

Apparatus for Measurements of the Electrical Conductivity of Rainwater with High Resolution in Space and Time

H. H. JONSSON AND B. VONNEGUT

State University of New York at Albany, Albany, New York

(Manuscript received 9 October 1990, in final form 2 February 1991)

ABSTRACT

Apparatus has been designed and constructed for real-time measurements of the electrical conductivity of rainwater. It utilizes a spinning disk that centrifuges and collects the rainwater falling on it. A micro conductivity cell is employed, which consists only of electrodes, and needs no embodiment to sustain the rain sample during measurement. Instead the liquid is retained between the electrodes by its own surface tension. Only the order of a microliter of rain water is needed to obtain a measurement. The system's response time is about a second. Test runs during thunderstorms and frontal rains reveal that variations in conductivity by up to a factor of 5 occur during a storm event. Maximum conductivities of up to $160 \mu\text{S cm}^{-1}$ usually occurred at the beginning of the storms. In one thunderstorm rainwater conductivity as low as $5 \mu\text{S cm}^{-1}$ was measured for a duration of a few minutes.

1. Introduction

The electrical conductivity of rain and cloud water is sometimes used as a general indicator of the pollution of the water because it increases with the concentration of ions which the droplets acquire from their environment. Cloud droplets are often nucleated by tiny salt or other soluble particles in the air, which dissolve and form ions. Such aerosol particles may also diffuse to the surfaces of cloud and raindrops, or be collected by collisions with falling rain. Gaseous pollutants in the air also can dissolve in cloud and rainwater and form ions. A large portion of the salt, alkali, and acidic aerosol particles present in the atmosphere are often due to natural sources (bubbles bursting in the ocean, sand or dust storms, volcanoes, forest fires, etc.). In recent decades, however, anthropogenic sources, such as smelters, power plants, chemical factories, automobiles, and cement factories have become increasingly important.

Ion concentrations in cloud and rainwater may vary by many orders of magnitude. A change in acidity by 1–2 pH units, corresponds to a change in concentration of the hydrogen ion by 1–2 orders of magnitude. The collection of a $1\text{-}\mu\text{m}$ sodium chloride particle by a raindrop will provide the drop with 10^{10}Na^+ and Cl^- ions. A $10\text{-}\mu\text{m}$ NaCl particle would thus increase the conductivity of a 1-mm diameter drop by about $10 \mu\text{S cm}^{-1}$. The electrical conductivity of a liquid, however,

is not only a function of ion concentration; it is also influenced by the ion mobilities, their valence and the liquid's temperature. The mobilities are highest for the hydrogen and the hydroxyl ions. For other common ion species the mobilities are two to five times lower. Temperature effects are typically about 2% per kelvin (Creighton 1943). Although conductivity measurements are a good indicator of dissolved electrolytes and ion concentrations, a drawback is that they do not provide information on the composition of the dissolved material.

Measurements of conductivity or acidity and other types of analyses of rainwater are usually based on samples of at least a few milliliters in volume. Frequently, samples are collected from raingages on a daily basis or subsequent to complete rain events. The time and space resolution of these measurements and analyses is, therefore, often rather poor. Gradients and fine structure in the pollution content of the rain are smoothed out. Anderson and Landsberg (1979), however, have reported on pH measurements obtained by use of a bucket that tips for every 0.25 mm of precipitation throughout the duration of storms. They felt they could resolve effects of a plume from a power plant and showed that precipitation acidity sometimes varied by as much as 2.9 pH units in the same storm.

We have designed and built apparatus of sufficiently rapid response to enable us to measure the electrical conductivity of rain water in real time. Rain samples of only the order of a microliter are needed to obtain a measurement. A spinning disk, centrifugal, rainwater collector provides continuous, rapid replenishment of the sample. In this paper we describe the system and

Corresponding author address: Dr. Hafidi H. Jonsson, State University of New York at Albany, Earth Science Building, Room 328, 1400 Washington Avenue, Albany, NY 12222.

present some of the measurements we have obtained with it.

2. The apparatus

The instrumentation designed and constructed for real-time measurements of the electrical conductivity of rainwater consists of a rapid rainwater collection system, a micro conductivity cell, and support electronics. In this section we will describe these components as well as the calibration of the system and its response characteristics.

a. The rain collector

Falling rain is collected on a Plexiglas disk, 14 cm in diameter, whose rim is elevated and concave on the inside. The disk is mounted on an electrical motor and spun at a rate of $1700 \text{ rev min}^{-1}$. Rainwater that lands on the disk is immediately centrifuged to the rim where it is collected and sucked into Teflon tubing. In less than a second it is carried by a stream of air, produced by a pump, through the conductivity cell.

b. The micro conductivity cell

The basic idea behind the fast conductivity measurements of rainwater is to design a very small conductivity cell that even at low rain rates can frequently be flushed. We have dispensed with the usual glass or plastic embodiment used to contain the two metallic electrodes and the liquid sample to be measured. Instead we retain a very small sample of rain water by its own surface tension. The principle involved may be illustrated as follows: if miniature electrodes were separated by a very small distance and the gap between them were exposed to a stream of air containing droplets of the liquid to be measured, the liquid would be collected directly into the gap between the electrodes and would wet and bridge it because of surface tension. The dominant forces acting on the bridge would be the surface tension force that tends to hold it together and the aerodynamic force, produced by the moving air, that tends to tear it apart. The surface tension force is proportional to the inverse of the bridge curvature radius and decreases in magnitude with the size of the bridge. The aerodynamic force is proportional to the area exposed and the square of the airspeed. As the bridge grows beyond a certain size, the aerodynamic force increases in magnitude while the surface tension force decreases. This produces a catastrophic instability. As additional liquid collects into the gap, an equivalent amount is, therefore, shed as a result of aerodynamic breakup. The bridge thus assumes a particular average size for which the two forces are in balance. The sample is sustained by its own surface tension and is continually replenished. No vessel is needed to contain it.

The design of the micro conductivity cell we constructed for the present measurements is illustrated in

Fig. 1. The electrodes are made of 2 small stainless steel machine screws whose ends have been ground to a hemispherical shape. These are mounted from opposite ends into a threaded hole through a piece of Plexiglas. The hemispherical ends meet in a cavity formed by an intersecting hole drilled through the Plexiglas at a right angle to the first. The electrodes are adjusted and fastened when their ends are separated by a distance of only about $10 \mu\text{m}$. Tubing is attached to the ends of the intersecting hole; one leading to the rain collector, the other leading to a water trap and a pump. The hemispherical shape of the electrodes makes the cell insensitive to fluctuations that might arise in the size of the water bridge. The cell constant is determined predominantly by only the small portions of the electrode surfaces that are closest together.

Thermal expansions and contractions of the Plexiglas probably cause variations in the cell constant. These variations would amount to a few percent per degree. This is of similar magnitude, but opposite in direction to the temperature variations in conductivity. The two temperature effects thus act to compensate each other.

c. The support electronics

A block diagram of the electronic support system is shown in Fig. 2. The system consists of a small amplitude, 1 kHz, low-impedance ac source, a current to

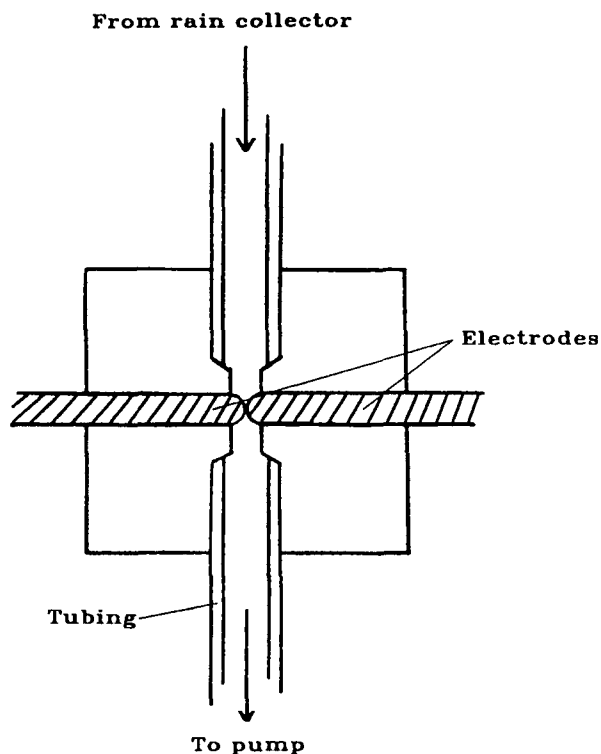

FIG. 1. A schematic illustration of the design of the micro conductivity cell.

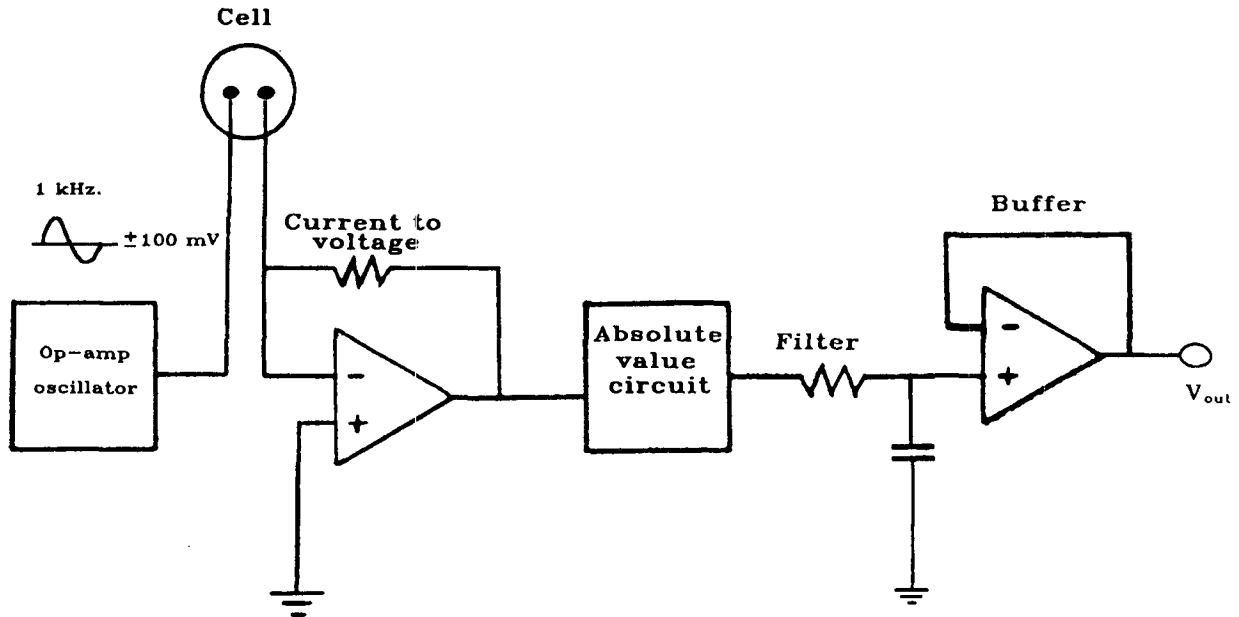

FIG. 2. A block diagram of the electronic circuitry supporting real-time measurements of the electrical conductivity of rainwater using the micro conductivity cell.

voltage amplifier, an absolute value circuit, and a filter. In order to minimize electrode effects, an ac of small amplitude is run through the micro conductivity cell. Its frequency is limited to 1 kHz to minimize the flow of significant currents due to capacitance. Bridge circuits were tried, but found impracticable because the large variations in conductivity encountered in rain resulted in gross nonlinearity and insensitivity whenever the bridge was not near balance. Instead, we have chosen to convert the current that flows through the cell in response to a constant amplitude ac excitation to voltage that is amplified, rectified, and filtered. The resulting dc output is nearly proportional to the conductance of the cell for a wide range of conductivity.

d. Calibration

The system was calibrated in the laboratory by allowing a solution having known conductivity to drip onto the spinning disk at a rate equivalent to a rain rate of a few millimeters per hour. For this purpose a bulk solution of potassium chloride (KCl) and distilled water was made and then successively diluted to produce the wide range of conductivities needed. A calibration curve was thus obtained prior to the rainwater measurements reported in the next section and again about six weeks later, after most of those measurements were done. The two calibration curves are shown in Fig. 3.

e. The system's response characteristics

Figure 4 illustrates some of the response characteristics of the system. The figure was obtained by adding

a number of drops having conductivities of 200 and 1 $\mu\text{S cm}^{-1}$ (distilled water) to a simulated background rain of 70 $\mu\text{S cm}^{-1}$ arriving to the spinning disk at an equivalent rain rate of 6.5 mm h^{-1} .

The figure shows how the addition of a 4-mm diameter drop, or a number of such drops, results in a

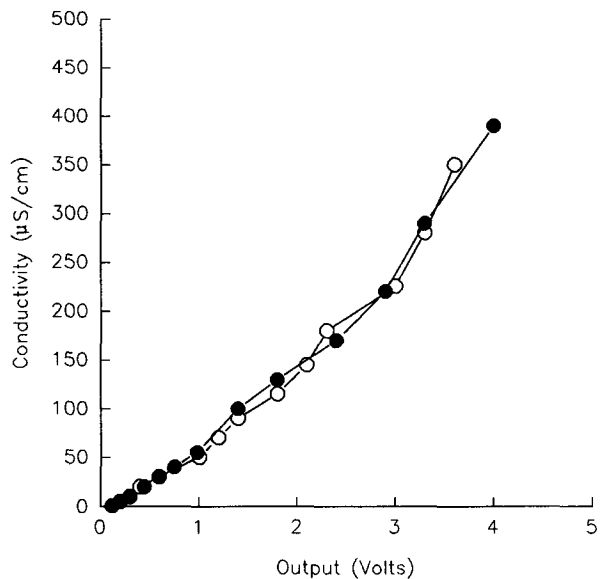

FIG. 3. Calibration curves obtained for the rainwater conductivity apparatus by dripping KCl solutions having known conductivities onto the spinning disk. Data represented by open circles were obtained on 15 June 1990, prior to the measurements in the field. Data represented by filled circles were obtained on 24 July 1990, after most of the field measurements.

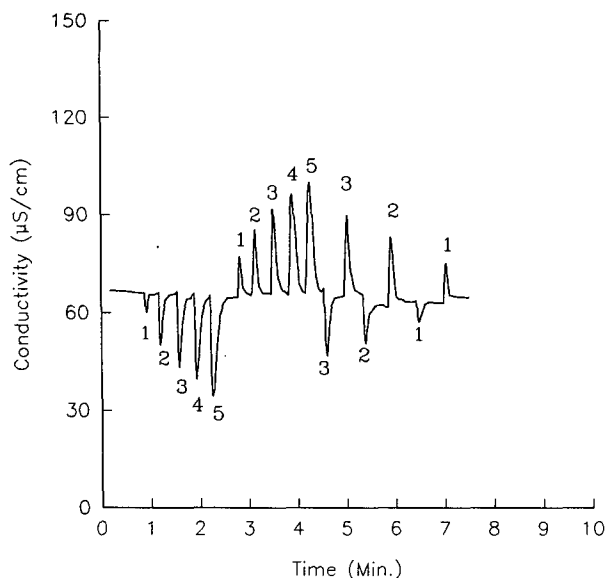

FIG. 4. The response of the apparatus to an addition of a number of 4-mm diameter drops having conductivities of 1 and $200 \mu\text{S cm}^{-1}$ to a simulated background rain of $70 \mu\text{S cm}^{-1}$ and equivalent rain rate of 6.5 mm h^{-1} . The number of drops added in each case is indicated at the tip of the resulting spikes.

sharp change in the indicated conductivity (the number of drops added is indicated at the tip of the resultant spikes in the figure). As expected, the direction of the change is towards lower conductivities when distilled water is added and towards higher conductivities when the $200 \mu\text{S cm}^{-1}$ solution is added. The magnitude of the change depends on the number of drops dispensed, increasing with the number. The signals rise to their peaks in about a second, but because the drops change the contamination of the disk and the tubing, the recovery to the background level takes longer. The recovery time in each case can be seen to be approximately 15 s. This indicates that since the simulated rain rate was 6.5 mm h^{-1} , the liquid volume needed to flush all contamination out of the system is only about 0.4 ml.

When the cell is drying out, for example, in the sub-saturated air after a rain event has ended, the evaporation and the associated diminution of the size of the water bridge between the electrodes causes an increase in the concentration of the ions present. Because of the shape of the electrodes this produces a spurious increase in the indicated conductivity. As a result a spike sometimes appears at the end of a run when the rain has stopped and water is no longer carried to the cell to replenish the bridge. Although the rate with which this occurs depends upon the humidity of the unsaturated air, the cell usually dried out within a minute of the end of the rain.

3. Experimental results

The system was tested in the field on the campus grounds of the State University of New York at Albany

in June and July 1990. Most of the runs were obtained during thunderstorms associated with frontal passages. Prior to each run the system was thoroughly flushed with distilled water, and in order to maintain it in clean condition, distilled water was kept dripping onto the spinning disk until the rain began.

The dc output from the amplifiers was recorded on a strip-chart recorder. The records thus obtained were subsequently digitized and converted to conductivity values by use of a fifth-order equation obtained by regression analysis of the calibration data (Fig. 3).

a. Case 1

Prefrontal warm sector thunderstorms occurred on 18 June 1990. There was a low pressure center over Quebec, Canada, moving east or northeast. A trailing cold front was approaching Albany, New York, from the west, and ahead of it within the warm sector, there was a line of thunderstorms also moving east. Around noon one of these thunderstorms passed over Albany, and another about two hours later.

Figures 5a,b show the electrical conductivity of the rain water of these two thundershowers as it evolved with time throughout their duration. The figures show considerable fine structure. In the earlier shower the conductivity fluctuates between 150 and $100 \mu\text{S cm}^{-1}$ and goes through 3–4 peaks and valleys before spiking as the cell dries out at the end of the storm. In the latter the conductivity reaches its highest values of about $130 \mu\text{S cm}^{-1}$ at the beginning of the storm and at the end. In between it goes temporarily as low as $50 \mu\text{S cm}^{-1}$.

b. Case 2

Frontal passage occurred on 27 June 1990. On this day there was a low pressure center over Newfoundland moving northeast and a trailing cold front moving across New York State. Ahead of the front the winds were westerly, but behind it they were from the north or northwest. It began to rain in Albany about 1730 EDT and continued raining for several hours. Measurements of the electrical conductivity of the rain were obtained from its onset.

Figure 6 shows the results of the approximate, two initial hours of the run. It shows an initial conductivity of about $100 \mu\text{S cm}^{-1}$ lasting for several minutes, and then a gradual decrease to values around $20 \mu\text{S cm}^{-1}$. The conductivity uneventfully remained around this value for a long time beyond what the figure shows. Aside from the gradual decrease in conductivity by a factor of five, the most striking features of the figure are the three spikes that show up between 0.5 and 1.0 h into the storm, where the conductivity suddenly increases by a factor of 2–3.

c. Case 3

A warm front approached on 12 July 1990. In this case there was a low pressure center slowly moving

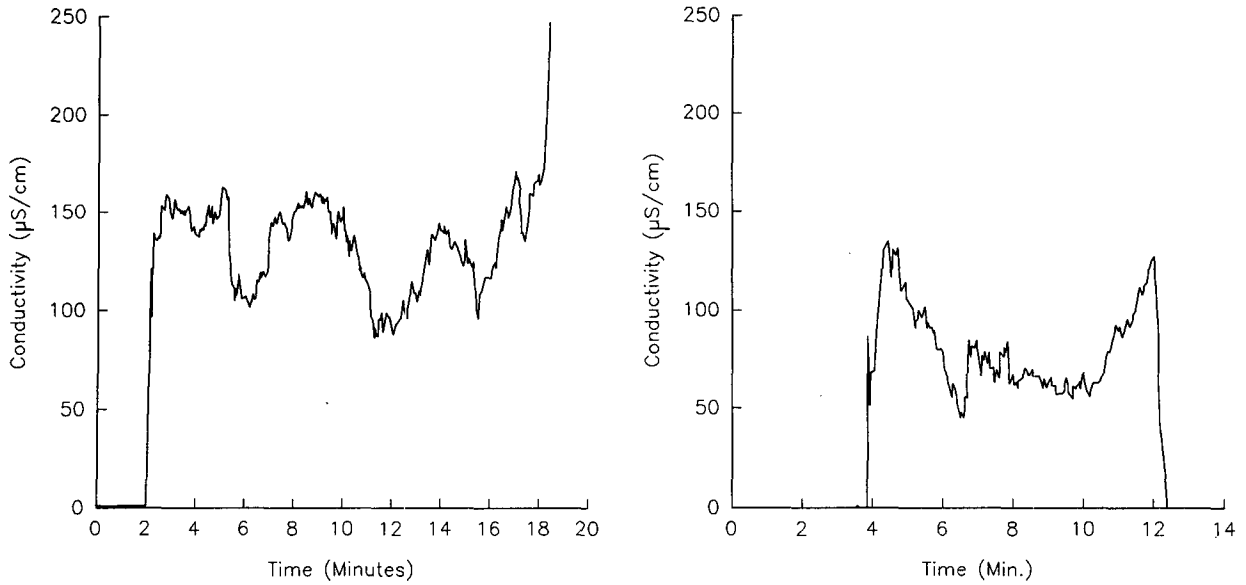

FIG. 5. (a) The electrical conductivity of rain produced by a thunderstorm on 18 June 1990 in Albany, New York, in high time resolution. Time T_0 is 1230 EDT. (b) A similar record for another thunderstorm that occurred later the same day. Here time T_0 is 1435 EDT.

into the Virginias and Pennsylvania from the southwest and there was southeasterly flow in Albany ahead of the warm front. It began to rain in Albany around 0600 EDT, but measurements of conductivity did not begin until noon.

Figure 7 shows the conductivity record for the remaining 4 h of continuous rain. Numerous sharp spikes toward lower conductivities are artifacts of occasional squirts of distilled water onto the spinning disk to check response and recovery times. Aside from those artifacts,

however, the figure shows marked fluctuations in conductivity with time, with values ranging from about 20 to as much as $100 \mu\text{S cm}^{-1}$.

d. Case 4

A thunderstorm occurred on 20 July 1990. After several days of southwesterly flow in Albany with the polar front over Canada, a wave developed on the front and traveled northeast just north of the Canadian bor-

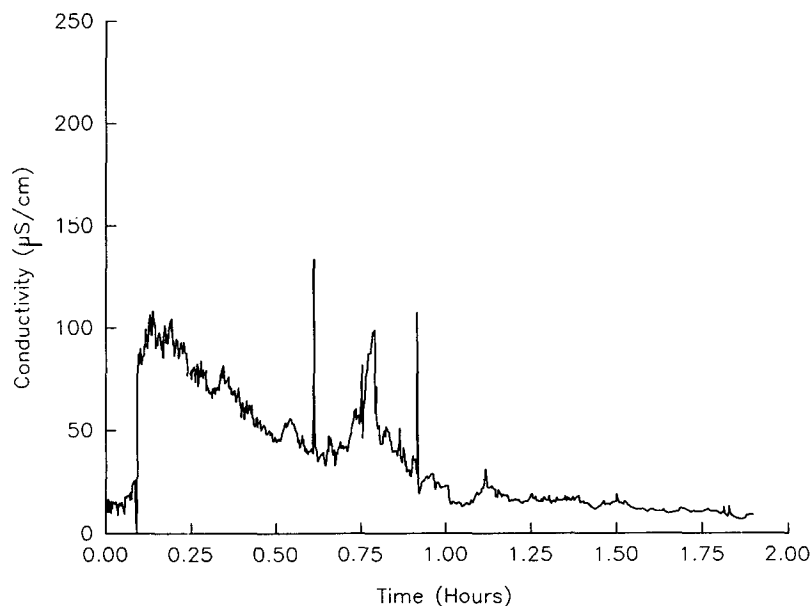

FIG. 6. The electrical conductivity of rain produced by the passage of a cold front on 27 June 1990 in Albany, New York, in high time resolution. Time T_0 is 1730 EDT.

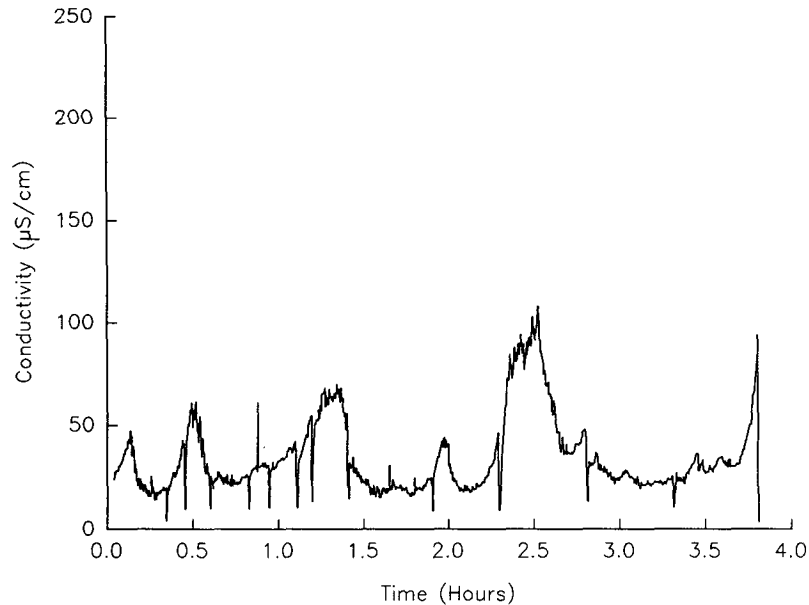

FIG. 7. The electrical conductivity of rain produced by an approaching warm front on 12 July 1990 in Albany, New York, in high time resolution. Time T_0 in the figure is 1200 EDT, but it had been raining for about 6 h before the measurements started.

der of New York State. Squalls of thunderstorms developed in its warm sector and on the afternoon of 20 July 1990 one of them crossed Albany.

Figure 8 shows the conductivity of the rain from that storm throughout its entire duration. Again a variation in conductivity by a factor of about 5 is observed. During the first 10 min the conductivity increases from about 100 to 150 $\mu\text{S cm}^{-1}$, but decreases thereafter to

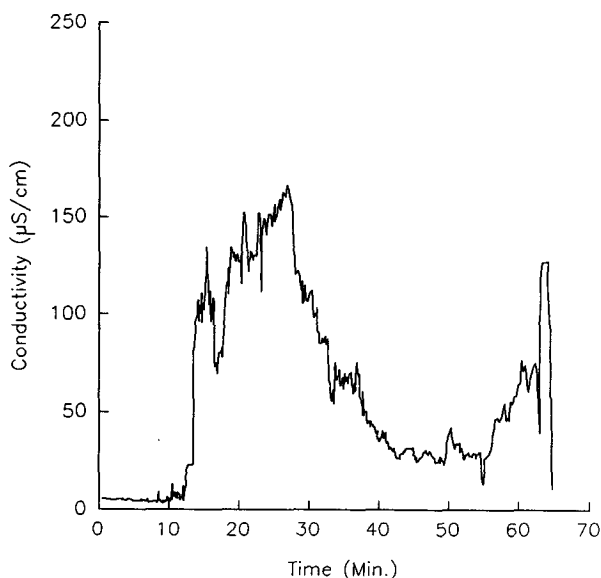

FIG. 8. The electrical conductivity of rain produced by a thunderstorm on 20 July 1990 in Albany, New York, in high time resolution. Time T_0 is 1615 EDT.

about 30 $\mu\text{S cm}^{-1}$ before increasing again at the end of the storm.

e. Case 5

A thunderstorm appeared on 23 July 1990. This thunderstorm developed on a cold front that was associated with a wave that had developed on the polar front and was moving eastwards just north of Albany. It had been raining earlier that day as the warm front came through and there had been only a short interval of dry weather before the storm moved in.

Measurements were obtained for the entire duration of this storm and the results are shown in Fig. 9. This figure is very similar in shape to Fig. 8, but the values obtained for the electrical conductivity of the water are generally much lower. At the beginning of the storm, the conductivity is only about 40 $\mu\text{S cm}^{-1}$, and after 15–20 min it drops for a short duration to only about 5 $\mu\text{S cm}^{-1}$, or to a value almost equivalent to that for distilled water. At the end of the storm the conductivity rises again and eventually peaks as the rain comes to an end.

f. Case 6

On 31 July 1990 a light afternoon shower occurred that was associated with the passage of a weak cold front. Measurements were obtained for the entire duration of the shower and the results are shown in Fig. 10. Here the conductivity stays between 80 and 100 $\mu\text{S cm}^{-1}$ for the first 15 min and then increases to its peak value of about 230 $\mu\text{S cm}^{-1}$ near the end of the shower.

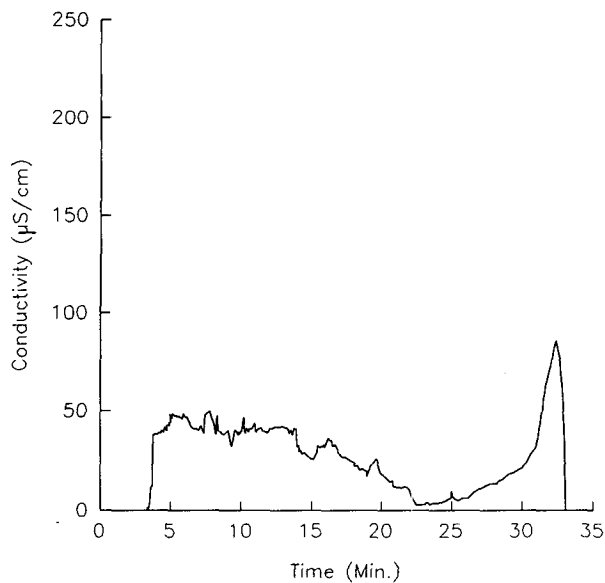

FIG. 9. The electrical conductivity of rain produced by a thunderstorm on 23 July 1990 in Albany, New York, in high time resolution. Time T_0 is 1610 EDT.

4. Discussion

The laboratory and the field runs reported previously demonstrate the practicability of the apparatus for obtaining real-time measurements of the electrical conductivity of the rainwater as it falls during a precipitation event. The stainless steel electrodes appear to be sufficiently, chemically inert to permit long-term utilization with no maintenance other than periodic flushing with distilled water. As evidenced by Fig. 2, the calibration of the system remained stable during six weeks of operation in the field.

The records showed remarkable variations in the conductivity of rainwater throughout the duration of storms as well as from one rain event to another. Maximum values of about $160 \mu\text{S cm}^{-1}$ were observed in several of the cases, usually at or shortly after the beginning of the rain. Minima, on the other hand, generally ranged from about $10\text{--}90 \mu\text{S cm}^{-1}$. During the thunderstorm of 23 July (Fig. 9), values as low as $5 \mu\text{S cm}^{-1}$ were measured for a duration of a few minutes. As examples of variations between isolated rain events, the earlier thunderstorm of 18 June produced rain with conductivities that never went below about $80 \mu\text{S cm}^{-1}$, but oscillated about a mean of about $120 \mu\text{S cm}^{-1}$, while the conductivity during the thunderstorm of 23 July never exceeded $50 \mu\text{S cm}^{-1}$. The short-term maximum values we observed were well within the range of bulk conductivities observed, for example, in the Appalachian Mountains and reported by Pierson et al. (1986) ($67\text{--}271 \mu\text{S cm}^{-1}$), but the short-duration minima were as much as an order of magnitude below the lower limit of that range.

The time scales of the fluctuations in conductivity we observed vary greatly. Large, gradual changes by as

much as a factor of five (for example, in Figs. 6, 8, and 9) are seen occurring in some cases over periods of 15–30 min. Superimposed upon them are smaller changes, some of which occur so fast that they may be caused by only a few drops. These small, rapid changes probably are real and not an artifact of the apparatus, because equally rapid and even larger changes could be produced on purpose, as illustrated in Fig. 7, by occasionally allowing distilled water to drip onto the spinning disk while collecting and measuring rain. Other significant changes in the conductivity records last up to a few minutes (Figs. 5, 6, and 8) and could represent plumes from local sources. Examples of this are the three conspicuous spikes seen in the record obtained during the frontal passage of 27 June (Fig. 6). These spikes are possibly due to a local source whose plume may occasionally have been carried towards the observation site by shifting winds. The apparent plumes in Fig. 7 may also be due to similar sources, but it is noteworthy that in this situation the low-level winds were generally from the southeast and may have been carrying aerosol of maritime origin.

Striking similarities show up in each of the three thunderstorm runs of Figs. 5b, 8, and 9. In the beginning of each of these storms the conductivity of the rain is high, relative to the rest of each storm, but decreases after a few minutes to significantly lower values before increasing again near the end of the storm. Possibly contributing to the higher values both at the storms' beginning and end is evaporation of the rain drops as they fall through subsaturated air and the resulting concentration of their ion contents. It is, however, probable that the high conductivity values at the beginning of these convective storms are mainly a result

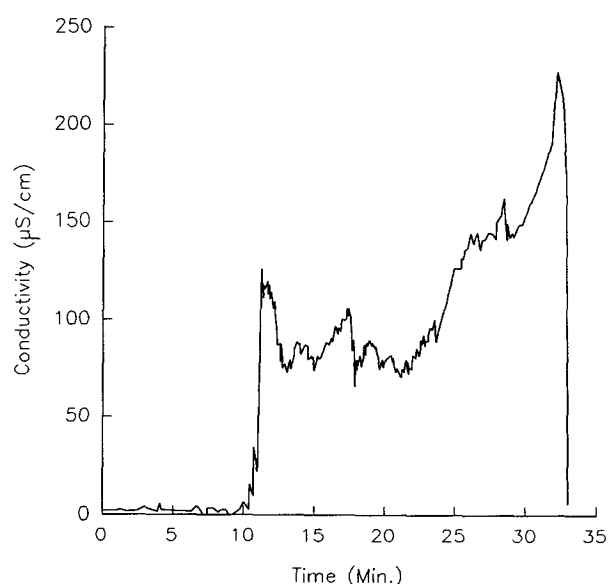

FIG. 10. The electrical conductivity of rain produced by a light afternoon shower on 31 July 1990 in Albany, New York. No lightning activity was associated with this shower. Time T_0 is 1340 EDT.

of scavenging and washout of aerosol particles and of droplets that have grown upon such particles in the lower atmosphere. Updrafts in the forward areas of the traveling thunderstorms could be expected to bring aerosol particles from lower levels into the clouds, where they make their way into droplets, and then through collisions and coagulation into precipitation particles. On the rear side of the storms, where downdrafts probably dominate (Browning and Ludlam 1962), the precipitation probably encounters much less pollution on its way to ground and is therefore less conductive. Similar evolution may also be responsible for the general trend towards decreasingly contaminated rain in the case of the frontal passage on 27 June (Fig. 6).

The conductivity of the rain produced by the earlier thunderstorm on 18 June and the light shower on 31 July (Figs. 5a and 10) evolves in a more complicated manner. The initial values are relatively high, but unlike the other convective storm situations, in these cases the conductivities remain generally high throughout the storms' duration. The variations in conductivity are proportionately smaller than in the other cases, and in the case of the shower, the highest conductivities are seen to occur towards its end. It is difficult to explain why these two storms are so different from the others. Throughout their duration it appears as if pollution was making its way into the precipitation. It is possible that this contamination was taking place locally due to a source somewhere upwind, but it may also be speculated that perhaps the circulations in these storms were fundamentally different from the others. The undulations in Fig. 5a, for example, may be the signature of a multicellular storm. Each wave in the figure lasts between 2 and 4 min, which translates into cell diameters of 1200–2400 m if the storm's translational velocity is assumed to be 10 m s^{-1} .

The fast conductivity apparatus we have described here may be valuable in a variety of circumstances.

Our utilization of it in the field has thus far mainly been for purposes of testing its performance and durability. As a result, our conclusions and interpretations beyond the raw data are limited and speculative. Obviously, the scientific value of the fast conductivity measurements of rainwater would be greater if these measurements were coupled to other meteorological measurements, such as wind speed and direction and measurements of rain rates and drop spectra, and complemented with knowledge of local sources of pollutants. It is also possible that the apparatus might be capable of providing information relevant to the nature of precipitation processes. Rain formed by the Wegener–Bergeron–Findeisen process, in which the ice particles grow by diffusion of water vapor onto their surfaces leaving the contamination of the source particles behind, should be less conductive than rain formed by coalescence, where the effects of the pollution of all particles participating in the process are cumulative. Finally, the apparatus is particularly well suited for investigations of transient sources of contaminants, and in the future we plan to utilize it to study the production of nitrogen oxides by lightning.

Acknowledgments. The authors gratefully acknowledge the contributions of Charles B. Moore during the original design and construction of this apparatus that were carried out at Langmuir Laboratory.

REFERENCES

- Anderson, D. E., and H. E. Landsberg, 1979: Detailed structure of pH in hydrometeors. *Environ. Sci. Technol.*, **13**, 992–994.
- Browning, K. A., and F. H. Ludlam, 1962: Airflow in convective storms. *Quart. J. Roy. Meteor. Soc.*, **88**, 117–135.
- Creighton, H. J., 1943: *Principles and Applications in Electrochemistry*. Fourth ed., John Wiley and Sons, 477 pp.
- Pierson, W. R., W. W. Brachaczek, R. A. Gorse, Jr., S. M. Japar and J. M. Norbeck, 1986: On the acidity of dew. *J. Geophys. Res.*, **91**, 4083–4096.