

# INDIRECT MEASUREMENTS OF ATMOSPHERIC TEMPERATURE PROFILES FROM SATELLITES: IV. EXPERIMENTS WITH THE PHASE 1 SATELLITE INFRARED SPECTROMETER

D. G. JAMES

British Meteorological Office, Bracknell, Berkshire, England

## ABSTRACT

A "breadboard" model of the proposed satellite infrared spectrometer for the measurement of atmospheric temperature profiles was used in two experiments at ground level. These were designed to demonstrate the feasibility of the instrument and to investigate some of the hazards involved in inverting the radiation integral. It is shown in the second experiment that realistic temperature profiles can be obtained when some smoothing of the observations is introduced.

## 1. INTRODUCTION

Kaplan [2] has described how the vertical temperature profile of the atmosphere may be obtained by measuring radiances in certain regions of the  $15\text{-}\mu$  band of carbon dioxide from a satellite. In order to examine this proposition practically, a suitable infrared spectrometer was constructed; it is described in detail by Hilleary et al. [1] in the third paper of this series. The present report describes the results of two groups of experiments using the "breadboard" model of the instrument at ground level. It is realized that operation near the ground causes severe limitations in the accuracy of the results, but the intention was only to obtain a qualitative estimate of the prevailing atmospheric temperatures over a limited distance, and to show how variations in this temperature could be detected by the spectrometer.

The experiments fall into two groups. In the first of these the instrument was located in a cool room and received radiation from a known path length at room temperature and also, via an open window which filled the field of view of the instrument, from the atmosphere outside, where the temperature was usually higher. In the second experiment, a vertical temperature sounding was attempted, the downward radiation reaching the spectrometer via a suitably inclined mirror. Several inversion techniques were applied to the data from both experiments in an attempt to reproduce the temperature profiles viewed by the instrument.

## 2. EXPERIMENTAL DETAILS

### EXPERIMENT I

The object of this experiment was to present the spectrometer with a temperature profile, part of which can be maintained constant, and part of which is variable.

To do this, (see fig. 1a) the instrument was mounted in a room about 3.7 m. from an open window. The room in which the instrument was located was 9 m. above ground level, but because of the  $6^\circ$  divergence of the field of view of the instrument it was still necessary to tilt the principal axis about  $8^\circ$  above the horizontal so as to exclude radiation from the ground and neighboring buildings.

The temperature of the room was controlled at about  $16^\circ\text{C}$ ., and the optical path length within the room contributed significantly to the intensities measured by the four channels. Radiation from the atmosphere beyond the open window also contributed to the radiation entering the spectrometer; the temperature outside the building varied between  $16^\circ\text{C}$ . and  $30^\circ\text{C}$ . during the period over which the experiments were performed. Thus, the temperature profile along the principal axis of the field of view of the spectrometer approximated a step function.

Within the small spectral ( $667.5$  to  $694.5\text{ cm}^{-1}$ ) and temperature ( $270^\circ$  to  $300^\circ\text{K}$ .) ranges of the experiments, it is feasible to linearize the Planck function by introducing a frequency-dependent coefficient  $\alpha(\nu)$  such that  $B(\nu, T) = \alpha(\nu) B(\nu_r, T)$ , where  $\nu_r$  is a reference wave number, taken in this instance to be  $667.5\text{ cm}^{-1}$ . The radiative integral equation

$$I(\nu_i) = \int_0^1 B[\nu_i, T(t)] d\tau(\nu_i, t), \quad i=1, \dots, 4, \quad (1)$$

may then be written as

$$\frac{I(\nu_i)}{\alpha(\nu_i)} = \int_0^1 B[\nu_r, T(t)] d\tau(\nu_i, t), \quad (2)$$

where the  $I(\nu_i)$  are the measured radiances,  $\tau(\nu_i, t)$  the

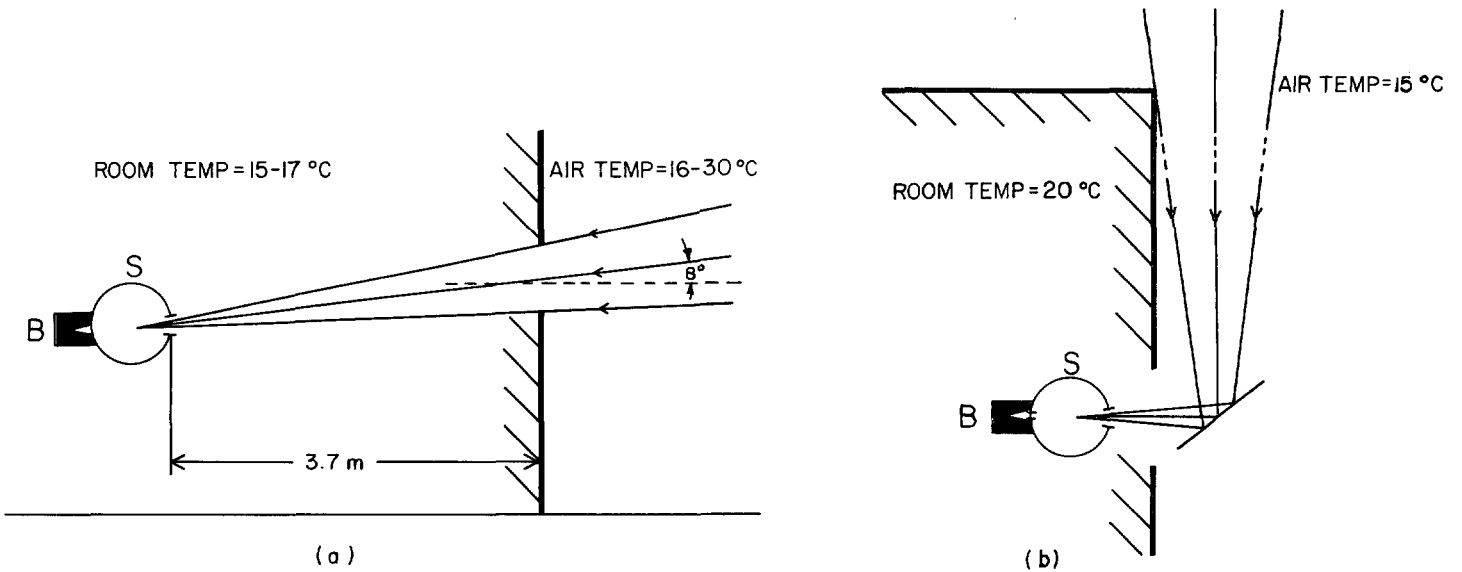

FIGURE 1.—Arrangement of the spectrometer (S) and its associated reference blackbody (B) for: (a) experiment I; and (b) experiment II. The external blackbodies used in the primary beam for calibration are not shown. The spectrometer was about 9 m. above ground level in each experiment.

transmittances at wave numbers  $\nu_i=667.5, 677.5, 688.5,$  and  $694.5,$  and the independent variable  $t$  is a function of the optical path length. The transmittances  $\tau(\nu_i, t)$  of the four channels were determined experimentally with a Beckman IR-7 spectrophotometer, adjusted so that its bandwidth was identical with that of the satellite spectrometer, and are shown in figure 2.

Table 1 presents the daily average values of  $I(\nu_i)/\alpha(\nu_i),$  together with the temperatures over each of the two ranges of the step function; two to six sets of data were obtained each day. From the calibrations (discussed by Hilleary et al. [1]), the errors in the individual radiances were found to be of the order of  $0.5 \text{ erg}/(\text{cm}^2 \text{ sec. strdn. cm}^{-1}).$

Each average value of the  $I(\nu_i)/\alpha(\nu_i)$  may be compared with the corresponding  $B(\nu_r, \bar{T}),$  where  $\bar{T}$  is an "average" temperature through the emitting layer. As the average temperature changes, corresponding changes may be observed in the means of the four radiances.

The table also demonstrates the weighting effect along the optical path length of the individual transmittances  $\tau(\nu_i, t)$  in equations (1) and (2). For example, the external temperature change from May 26 to May 28 was about  $13^\circ \text{ C.},$  which produced a change of 9.8 and  $14.4 \text{ ergs}/(\text{cm}^2 \text{ sec. strdn. cm}^{-1})$  at  $667.5$  and  $696.5 \text{ cm}^{-1},$  respectively.

EXPERIMENT II

Figure 1b shows the experimental arrangement by which downward radiation from atmospheric emission was allowed to fall via a suitably inclined mirror onto the entrance of the infrared spectrometer; the optical path

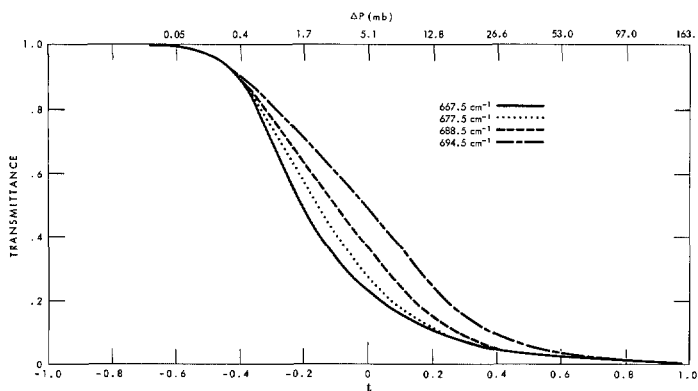

FIGURE 2.—Transmittances as linear functions of the variable  $t=[C_1(\Delta p)^{1/5}+C_2]$  (lower scale) and as non-linear functions of  $\Delta p$  (upper scale).

TABLE 1.—Daily averages of measured values for experiment I. Spectral radiances are given as  $I(\nu)/\alpha(\nu)$

Date (1962)	Room Temp. (°C.)	Air Temp. (°C.)	Radiances [erg/(cm. <sup>2</sup> sec. strdn. cm. <sup>-1</sup> )]					
			$\nu$ (cm. <sup>-1</sup> )				Mean	$B(\nu_r, \bar{T})$
			667.5	677.5	688.5	694.5		
24 May	16-17	27-28	141.7	144.4	145.2	147.4	144.7	144.3
25 May	16-17	27-28	141.8	144.3	144.5	145.5	144.0	144.3
26 May	15-17	28-30	141.2	144.2	145.0	146.1	144.1	145.2
28 May	15-16	16-17	131.6	131.8	131.6	131.7	131.7	131.7
29 May	15-16	22-23	136.4	138.5	138.5	138.8	138.1	139.0

TABLE 2.—Spectral radiances,  $I(\nu)/\alpha(\nu)$ , for experiment II, July 27, 1962.

Run	Time (EST)	Radiances [erg/(cm. <sup>2</sup> sec. strdn. cm. <sup>-1</sup> )]			
		$\nu$ (cm. <sup>-1</sup> )			
		667.5	677.5	688.5	694.5
1	0207-0229	131.0	132.4	132.8	133.1
2	0315-0335	131.2	132.5	132.3	132.3
3	0414-0436	131.6	132.5	132.2	132.2

between the mirror and the spectrometer was made as short as possible. A blackbody at a known temperature was positioned so that it could be moved quickly into the beam to provide a calibration check of the instrument during the experiment. Thermocouple measurements of the air temperature were taken at points roughly 3 m., 6 m., and 15 m. above the mirror, and the remaining portions of the temperature profiles were obtained from the radiosonde at nearby Sterling, Va. To reduce any noise on the radiation record which might be produced by convective turbulence, the experiment was conducted between 0100 and 0445 EST on July 27, 1962; sunrise was at 0453 EST. The morning was cloudless and the outside air temperature was reasonably constant at about 15° C.

In spite of the precautions taken, considerable random noise was evident on the radiation trace, so that a form of smoothing and correction was necessary to obtain a realistic mean signal. This was accomplished by allowing each radiation measurement to extend over several minutes so that a sufficient length of record was available to make a statistical correction. Values of  $I(\nu_i)/\alpha(\nu_i)$  are presented in table 2, and the random errors of observation are about the same as in experiment I. The atmospheric transmittances for this experiment are almost identical with those shown in figure 2 for the first experiment.

### 3. SOLUTIONS DIRECT METHODS

Yamamoto [6] described a method of inverting the radiative transfer equation (1) or (2) to obtain the temperature as a continuous function of  $t=[C_1(\Delta p)^{1/5}+C_2]$  using various polynomials; the variable  $\Delta p$  is proportional to the optical path length of carbon dioxide. In experiment II,  $\Delta p$  is the difference between the surface pressure and the pressure level  $p$ ; in experiment I,  $\Delta p$  is the equivalent in a quasi-horizontal path. Yamamoto's technique was applied to the results obtained in both experiments. Figure 3 presents solutions of third degree Legendre polynomials obtained from the four sets of data obtained during the first experiment on May 26, 1962. Also shown is an estimate of the true atmospheric temperature based on thermocouple measurements, and, farther from the instrument, an assumed adiabatic lapse rate. This case is typical of the results obtained for that series of experi-

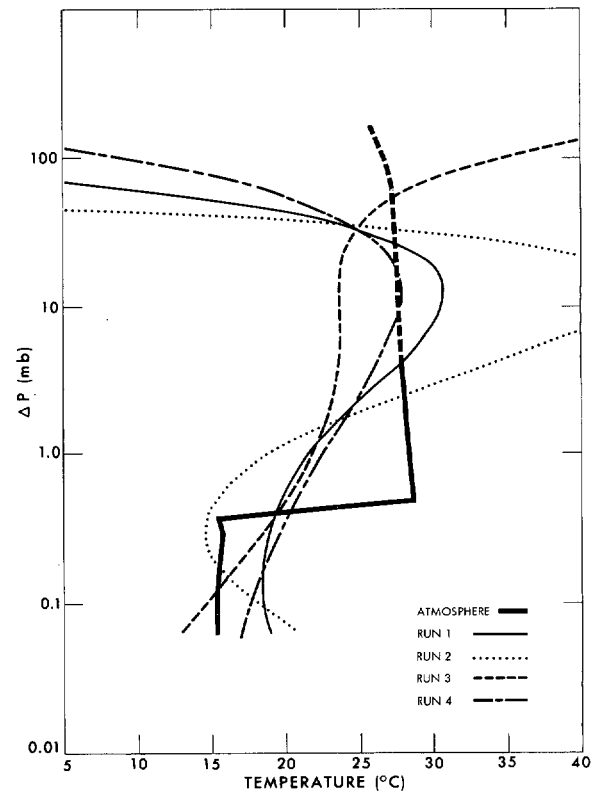

FIGURE 3.—Third degree Legendre polynomial solutions from experiment I. Four sets of observational data obtained on May 26, 1962 were employed.

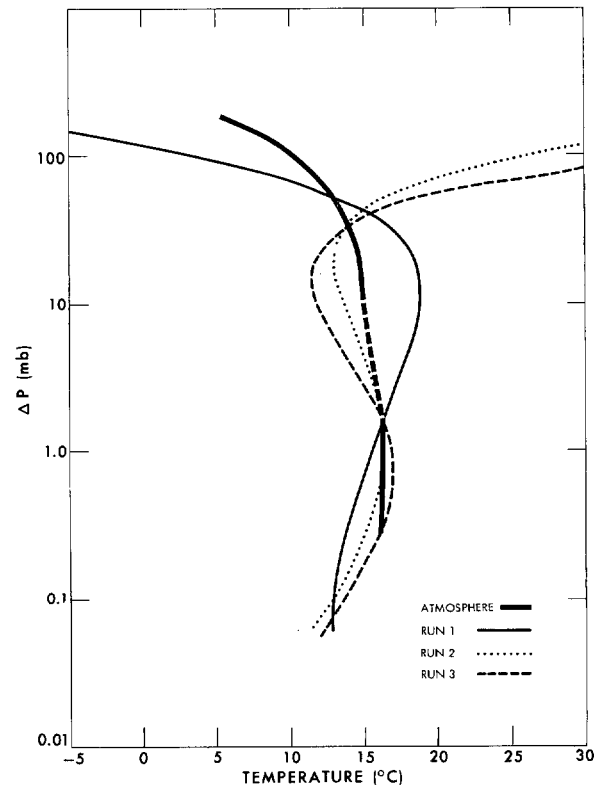

FIGURE 4.—Third degree Legendre polynomial solutions from experiment II. The data shown in table 2 for July 27, 1962 were employed.

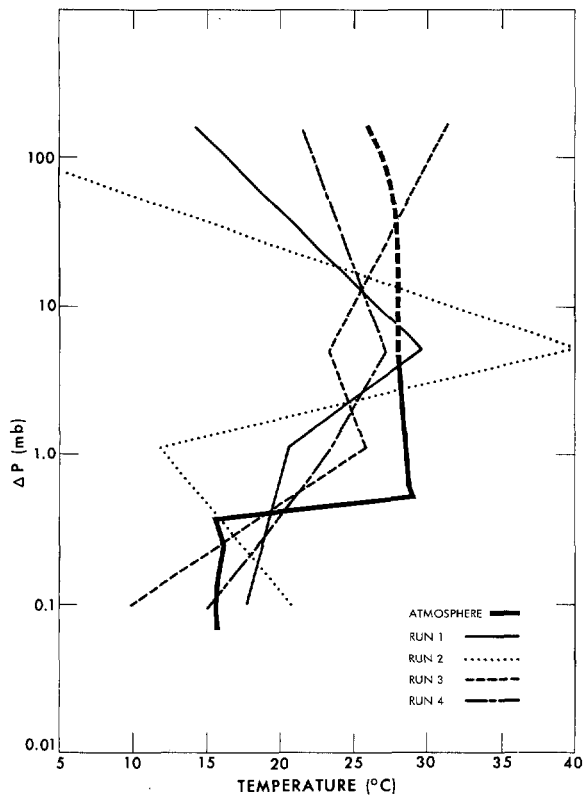

FIGURE 5.—Point-and-slope solutions for experiment I, using the same observational data employed in figure 3.

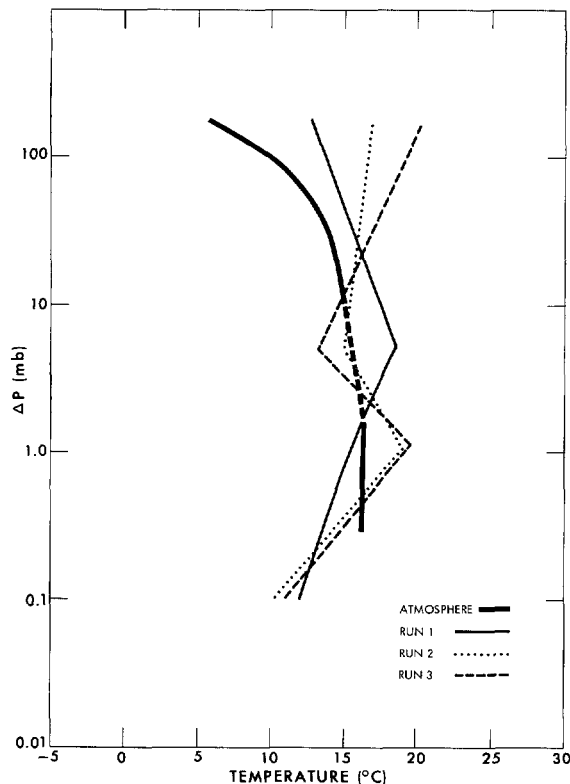

FIGURE 6.—Point-and-slope solutions for experiment II, using the same observational data employed in figure 4.

ments. Figure 4 shows comparable solutions for experiment II; the true atmosphere here is represented by radiosonde and thermocouple measurements.

For both experiments, it is clear that the exact cubic solution is not a good fit for the probable temperature profile, nor is the solution consistent for measurements immediately following one another.

Wark [4] has shown that by integrating the transfer equation by parts it is possible to introduce the simple assumption that over a certain range of pressure  $\partial B/\partial(\log p)$  is a constant, which is almost the same as saying  $\partial T/\partial(\log p)$  is constant. Assume three such regions by choosing the pressure intervals to be 0.1 to 1.1 mb., 1.1 to 5.1 mb., 5.1 to 163.1 mb.; then the four radiance measurements yield three slopes within the regions indicated and the temperature at 0.1 mb.

The solutions applied to the four sets of observations of May 26 and the three sets of observations of July 27 are presented in figures 5 and 6, respectively. It is again obvious that the solutions show considerable inconsistency, although the measured radiances arise from essentially constant temperature profiles.

These polynomial and point-slope techniques demonstrate the conclusion of Wark and Fleming [5] in the first paper of the series, namely, that the direct methods of solution are unstable.

#### QUADRATIC SOLUTION

The theoretical discussion by Twomey [3] suggests that in order to obtain a stable solution, some degree of smoothing is necessary. This can be accomplished rather crudely by assuming that we have an over-determined system and that, instead of solving for a cubic representation of  $B[\nu, T(t)]$ , we assume the solution to be quadratic. We now have four equations to determine the three necessary coefficients by least squares. This has been done for the data in both experiments, and the results for May 26 and July 27 are shown in figures 7 and 8.

Not only is the quadratic solution a better fit to the temperature profile, but the solutions are now consistent for consecutive observations of essentially the same profile.

#### THE USE OF EMPIRICAL ORTHOGONAL FUNCTIONS

The expansion of the solution in terms of empirical orthogonal functions, as suggested by Wark and Fleming [5] in the first paper of this series, should be particularly advantageous when the number of sensors employed is small, since, by the method of derivation, most of the variance in the temperature field is accounted for by the low-order terms. This method has been attempted using the radiances measured during experiment II in conjunction with the smoothing technique described by Twomey [3] for solving a set of linear simultaneous equations involving observations with random errors.

Surprisingly, the solutions evaluated in this way are not as good as those obtained from the quadratic solution.

It is thought that the reason for this is that the sample soundings were too homogeneous a set, so that the empirical orthogonal functions calculated were not able sufficiently to express large departures from the mean. This was not pursued any further because the entire question of choosing adequate sample sets is being examined currently in a separate context.

#### 4. DISCUSSION

The object of this group of experiments was threefold. Firstly, to show that the intensities recorded by the four channels were representative of the temperature of the CO<sub>2</sub> along the line of sight of the instrument. Secondly, to show that a variation of temperature at a distance could produce a measurable change in the intensities, and thirdly, to attempt to obtain the temperature profile along the principal axis of the spectrometer by inverting the radiation integral using various inversion techniques.

From table 1 it can be seen that the average  $I(\nu)/\alpha(\nu)$  agrees well with the Planck function at 667.5 cm.<sup>-1</sup> of the average temperature along the path within the limited range of temperatures experienced. Furthermore, for a constant indoor temperature, variations in the outside temperature produce changes in the intensities which differ from channel to channel. This can best be seen from table 1 by comparing the differences between the averages of channels 1 and 4 for different days.

In attempting to obtain the atmospheric temperature profile by using the radiances recorded by the four channels, we have followed the methods suggested by both Yamamoto [6] and Wark [4]. Both methods of solution are unsatisfactory, in accordance with the discussion by Wark and Fleming [5]. To obtain a stable solution, restrictions must be imposed upon the inversion procedure. One such restriction would be to reduce the order of the polynomial expansion of  $B[\nu_r, T(t)]$ . The solution of a quadratic rather than a cubic atmospheric temperature profile has been shown to be more realistic and more stable. The temperature profile of experiment I obviously cannot be represented well by a low-order polynomial, but it is encouraging to observe that all of the quadratic solutions give increasing temperatures with distance from the spectrometer (at  $\Delta p = 0$  mb.). The vertical temperature profile can be represented much better by a low-order polynomial, and the results of figure 8 are, in general, reasonable fits to the probable sounding. In both cases the consistency among the several solutions has been greatly improved by the reduction of the order of the expansion.

The use of empirical orthogonal functions with smoothing still holds the greatest promise (cf. Wark and Fleming [5]). However, care must be exercised in selecting the sample sets, particularly with respect to the diversity of the set.

One must conclude that the results are quite limited quantitatively, essentially because of excessive errors of measurement. These errors are the result of rather noisy measurements which had to be averaged over long time

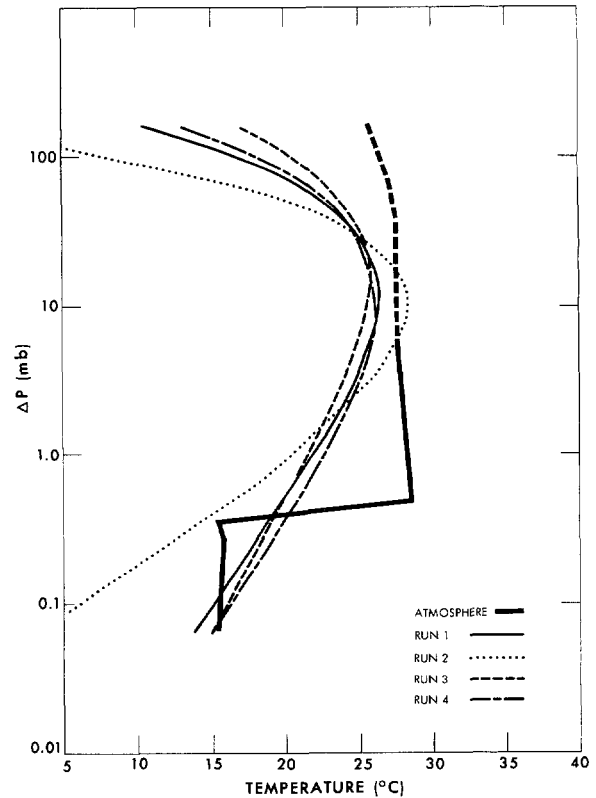

FIGURE 7.—Least squares solutions for experiment I using quadratic representations and the same observational data employed in figure 3.

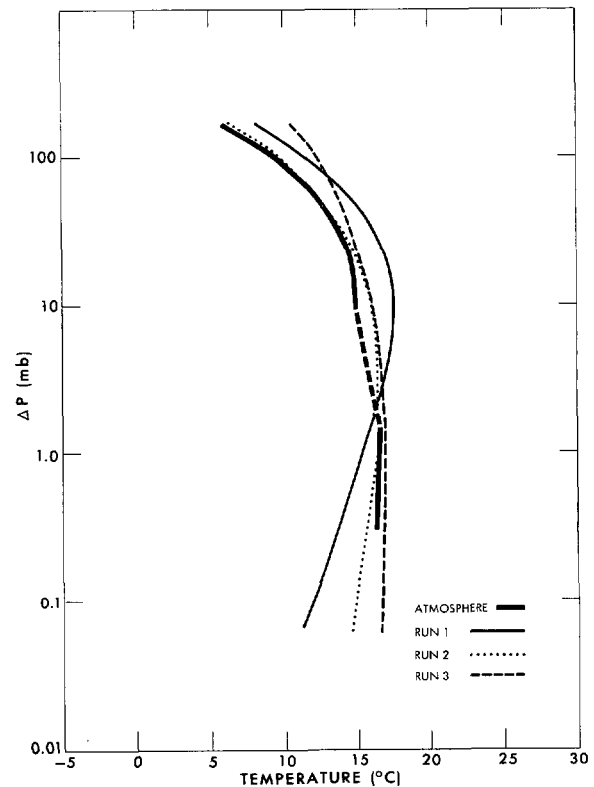

FIGURE 8.—Least squares solutions for experiment II using quadratic representations and the same observational data employed in figure 4.

intervals, and the sequential (rather than simultaneous) monitoring of the output of each of the four channels.

The methods of inversion (with the exception of the direct methods) are not essentially at fault. In this regard the negative effect upon the shape of the transmittance curves of a homogeneous atmosphere or one of decreasing density (as opposed to one of increasing density as in the satellite situation) is of far greater importance.

From the qualitative point of view (which is the primary one of this paper) the experiments were a success. It was, therefore, decided that there was sufficient reason to proceed with the next phase of the program, which is discussed in the third and sixth papers of this series.

#### ACKNOWLEDGMENTS

The success of these experiments was ensured by the contribution of several people, some of whom have other papers in this series. The maintenance and calibration of the spectrometer were mainly the responsibility of Mr. L. D. Johnson and Mr. E. E. Champion, to whom I wish to express my sincere thanks. The transmittances in figure 2 were computed from experimental data provided by Mr. Martin Wolk.

#### REFERENCES

1. D. T. Hilleary, E. L. Heacock, W. A. Morgan, R. H. Moore, E. C. Mangold, and S. D. Soules, "Indirect Measurements of Atmospheric Temperature Profiles from Satellites: III. The Spectrometers and Experiments," *Monthly Weather Review*, vol. 94, No. 6, June 1966, pp. 367-377.
2. L. D. Kaplan, "Inference of Atmospheric Structure from Remote Radiation Measurements," *Journal of the Optical Society of America*, vol. 49, No. 10, Oct. 1959, pp. 1004-1007.
3. S. Twomey, "The Application of Numerical Filtering to the Solution of Integral Equations Encountered in Indirect Sensing Measurements," *Journal of the Franklin Institute*, vol. 279, No. 2, Feb. 1965, pp. 95-109.
4. D. Q. Wark, "On Indirect Temperature Soundings of the Stratosphere from Satellites," *Journal of Geophysical Research*, vol. 66, No. 1, Jan. 1961, pp. 77-82.
5. D. Q. Wark and H. E. Fleming, "Indirect Measurements of Atmospheric Temperature Profiles from Satellites: I. Introduction," *Monthly Weather Review*, vol. 94, No. 6, June 1966, pp. 351-362.
6. G. Yamamoto, "Numerical Method for Estimating the Stratospheric Temperature Distribution from Satellite Measurements in the CO<sub>2</sub> Band," *Journal of Meteorology*, vol. 18, No. 5, Oct. 1961, pp. 581-588.

[Received November 7, 1966; revised April 27, 1967]