

## The Acoustic Measurement of Water-Drop Impacts

P. I. A. KINNELL

*Division of Soils, CSIRO, Canberra, A. C. T., Australia*

(Manuscript received 4 October 1971, in revised form 11 February 1972)

### ABSTRACT

An electro-acoustic device, sensitive to the size, shape and velocity of falling water drops, is described. Observations with this device suggest that the acoustic impact of drops traveling below terminal velocity may be of an inelastic nature.

### 1. Introduction

The peak amplitude of a pulse produced by the impact of raindrops on an electro-acoustic device has been used for the airborne determination of drop-size spectra (Cooper, 1951; Cunningham, 1951; Katz, 1952; Imaynitov *et al.*, 1966). Two types of transducer have been used in such devices: type 1, in which the electrical system is mechanically linked to the target and type 2, in which the oscillations from the target are transmitted through a fluid to a microphone. It is generally assumed, with both types of device, that the peak amplitude of the pulse is a function of the momentum of the drop. Although experiments by Mikhaylovskaya (1964), with a type 1 device, indicated a relationship between the peak amplitude and the product of the square of the equivalent spherical diameter of the drop and the first power of the velocity of the drop relative to the pick up, her experiments cannot be considered to be conclusive. This is because the data were markedly scattered and the later study by Imaynitov *et al.* on this type of device suggested that the peak amplitude was related to the momentum of the drop.

This paper presents some observations on laboratory experiments with a type 2 device in which the transmission medium is air. Although the device considered here was not designed for the determination of raindrop size, but to produce a measure of the erosive power of rainfall, the investigations give some indication of the nature of the drop impact and its use as a basis for a disdrometer.

### 2. Transducer and analyzer

The transducer is diagrammatically shown in Fig. 1. It consists of two 18 gauge aluminum dishes (flat surface, 18.5 cm in diameter) bolted together at their edges, the upper dish acting as the target while the lower dish houses the microphone 4 cm below the target. The analyzer was designed to store the peak amplitude of the pulse for a sufficient period to allow recording by a digital voltmeter.

### 3. Procedure

Eleven drop sizes, ranging from 2.7 to 6.1 mm equivalent spherical diameter, were produced, using

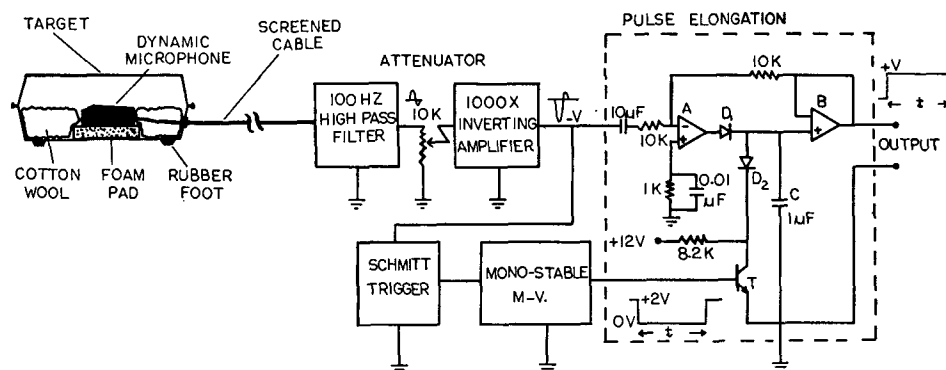

FIG. 1. Schematic diagram of the transducer and analyzer: A =  $\mu$ A741C, B = LM302, D<sub>1</sub> and D<sub>2</sub> = AN1105, T = 2N3565. A positive input pulse causes T to be switched off and reverse bias D<sub>2</sub>. C therefore becomes charged to the maximum amplitude of the pulse and remains so until T is switched on again. The monostable multivibrator controls the time ( $t$ ) for which T is switched off.

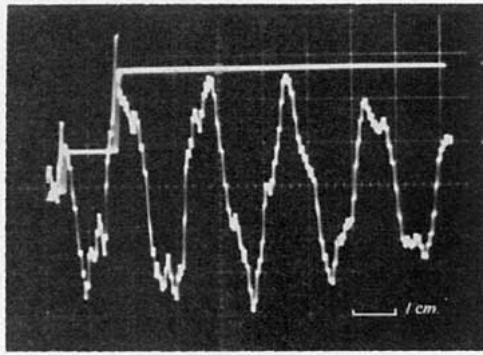

FIG. 2. Pulse produced by the impact of a drop at the center of the dry target (time scale, 2 msec cm<sup>-1</sup>; voltage scale, 2 V cm<sup>-1</sup>).

distilled water at about 20C, from appropriate sizes of glass or plastic tubes. Drop size was obtained by weighing 10–20 drops, collected in oil, for each selected combination of size and velocity. For each drop size, impact velocity was varied by adjusting the height of fall in accordance with the observations of Laws (1941).

A linear decline in response was observed as the distance of the point of impact increased from the center of the target. Consequently, the peak amplitude of the pulse was determined only for drops falling at the center. To maintain this condition, the maximum height of fall had to be limited to 1.8 m, thus limiting the maximum impact velocities used to 61% of the terminal velocity for the largest drop and 67% for the smallest. The target was dried before each impact. The average standard deviation in measured peak voltage for these conditions was 0.65%.

4. Observations

a. Pulse shape

Fig. 2 shows the typical waveform produced by the impact of a drop on the transducer (the stepped line shows the output from a prototype of the analyzer). Fig. 3 shows the waveform produced by a glass sphere of similar size and velocity. While a fundamental fre-

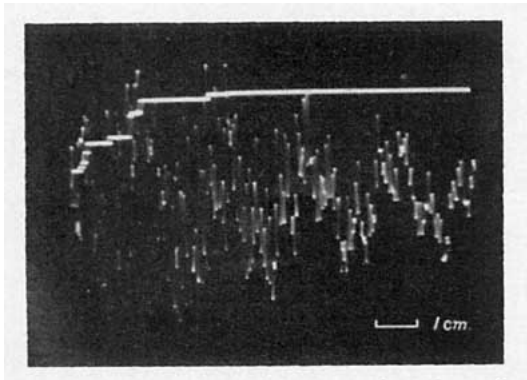

FIG. 3. Pulse produced by the impact of a glass sphere at the center of the dry target (time scale, 2 msec cm<sup>-1</sup>, voltage scale, 2 V cm<sup>-1</sup>).

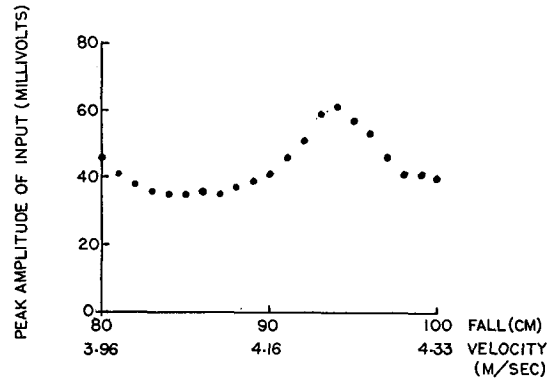

FIG. 4. The effect of small changes in fall height on peak voltage for a 5.4-mm drop.

quency of ~300 Hz is apparent in both cases, the glass sphere produces a disturbance which includes much higher frequencies than the disturbance produced by drops. The presence of a water film on the diaphragm tends to attenuate the higher frequencies, leading to a reduction in peak amplitude recorded for glass spheres. However, an increase in the peak amplitude was observed for the drops.

b. Drop shape

Small changes in height of fall of large water drops produced a variation in peak amplitude which could not be accounted for by the small alteration in the calculated velocity of the drops (Fig. 4). Because oscillatory variations in drop shape with distance of fall were observed from photographs [obtained by the technique described by Pfeiffer (1963)], the vertical and horizontal extents of the drops at the position of impact were recorded from these photographs. The maximum peak amplitude recorded corresponded with the times when the drop was in its most flattened state.

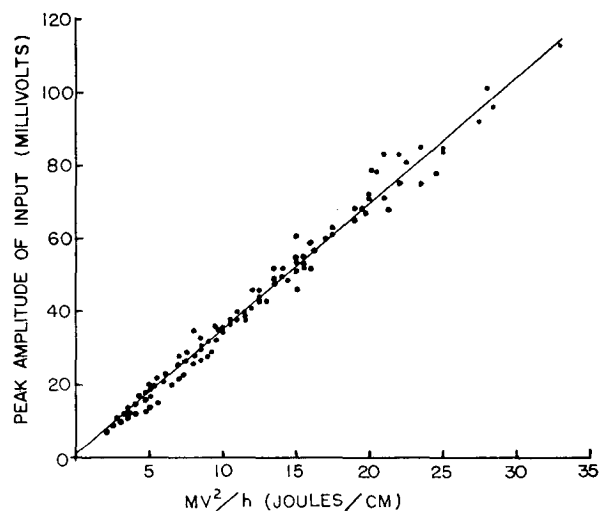

FIG. 5. Scatter plot of the peak pulse amplitude against inelastic impact for water drops.

*c. Drop size and velocity*

From Mikhaylovskaya (1964), the following relationships for elastic and inelastic impact are obtained:

FOR ELASTIC IMPACT

$$U = k_1mv/t = k_2mv/d, \tag{1}$$

where  $U$  is the peak voltage, and  $t = d/(\text{velocity of sound in water})$ .

FOR INELASTIC IMPACT

$$U = k_3mv/t_1 = k_4mv^2/d, \tag{2}$$

where  $t_1 = d/(2v)$ ,  $k_1, k_2, k_3, k_4$  are constants,  $m(\text{gm})$  is drop mass,  $v(\text{cm sec}^{-1})$  is drop velocity,  $t$  and  $t_1$  are the durations of impact, and  $d(\text{cm})$  is the equivalent spherical diameter of the drop.

In the case of inelastic impact, the duration of impact ( $t_1$ ) depends on the vertical extent ( $h$ ) of the drop. We can therefore substitute  $h$  for  $d$  to give

$$U = kmv^2/h. \tag{3}$$

Least-squares regressions generated for various combinations of  $m, v, d$  and  $h$ , as given by Eqs. (1)–(3), the substitution of  $d$  by  $h$  in Eq. (1), and for kinetic energy and momentum gave correlation coefficients in excess of 0.93 in all cases (Table 1). Eq. (4) accounted for 98.5% of the variation in the regression equation and gives a standard error of 3.0 V:

$$U = 0.001706mv^2/h + 1.1348, \tag{4}$$

is where  $U$  is 1000 times the input voltage. The scatter plot for the data is shown by Fig. 5.

Regressions generated for data groups according to fall height, drop size and drop shape (ratio of vertical to horizontal extent) maintained correlation coefficients and standard errors in favor of Eq. (3). Although a strong correlation exists for inelastic impact, the regressions generated according to drop size tend to show a progressive increase in the regression constant with increasing size for inelastic impact (Fig. 6). This suggests that there is a variation in the degree of in-

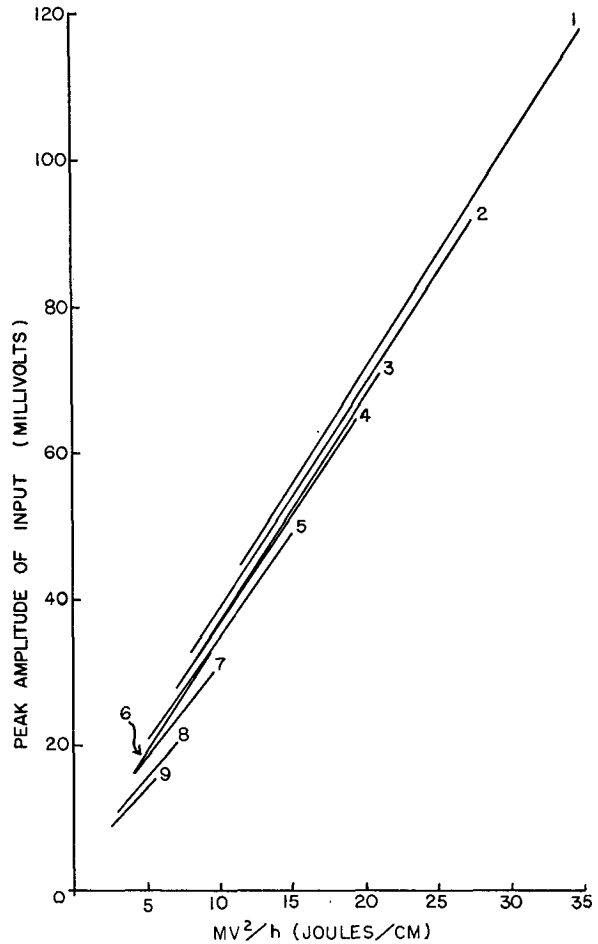

FIG. 6. The effect of water-drop size on the relationship between peak pulse amplitude and inelastic impact: (1) 5.88–6.10 mm, (2) 5.10–5.38 mm, (3) 4.80–4.92 mm, (4) 4.65–4.68 mm, (5) 4.29–4.33 mm, (6) 3.77–4.16 mm, (7) 3.62–3.66 mm, (8) 3.16–3.26 mm, (9) 2.74–2.79 mm.

elasticity according to drop size, such that the smaller the drop, the greater its ability to resist collapse on impact.

*d. Drop collapse*

Sequential photographs during the impact of the largest drop size used in this study show that the drop tends to disintegrate by radial flow from the base of the drop along the plate with no apparent distortion of the rest of the drop (Fig. 7). The time taken for the drop to collapse corresponds to the time calculated from the velocity and vertical extent of the drop. If the duration of the collapse of a drop on a body which can oscillate exceeds the time required for that body to move from its point of equilibrium to its maximum point of deflection, then the collapse of the drop will tend to interfere with the natural oscillations of the body. Because the fundamental frequency of the target appears to be in the order of 300 Hz, regressions were

TABLE 1. Values for regression and correlation constants and coefficients for peak voltage for various combinations\* of  $m, v, d$  and  $h$ .

Combination (X)	$U = bX + a$ , where $U = 1000 \times \text{input voltage}$			
	$b$	$a$	Correlation coefficient	Standard error
$mv/d$	0.9876	-7.4538	0.955	7.55
$mv/h$	0.9202	-6.1458	0.983	4.62
$mv^2/h$	0.001706	1.1348	0.993	3.03
$mv$	1.4246	6.9711	0.938	8.73
$mv^2/2$	0.0057	9.8257	0.966	6.49

\* Range of  $m$ , 11–121 mg; range of  $v$ , 3.2–5.6 m sec<sup>-1</sup>; number of observations 109. All correlation coefficients are significant at the 0.001 level.

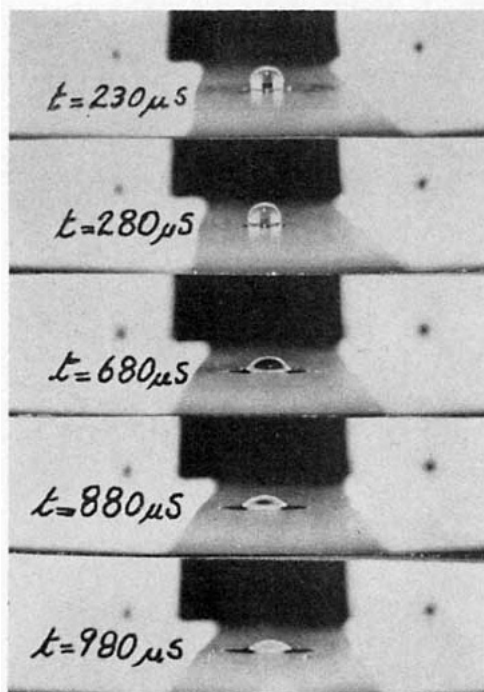

FIG. 7. Sequential photographs of collapse of 6.1-mm drop with impact velocity of  $3.9 \text{ m sec}^{-1}$ . Time  $t=0$  is time when sound is initiated in target (calculated transmission time to microphone  $130 \mu\text{sec}$ ).

calculated for the grouping of the data according to the calculated collapse time being greater than or less than  $830 \mu\text{sec}$ . For the greater than  $830\text{-}\mu\text{sec}$  data, Eq. (3) showed the highest correlation ( $r=0.993$ ). However, for the shorter collapse-time data, kinetic energy ( $r=0.998$ ), momentum ( $r=0.998$ ) inelastic ( $r=0.997$ ) and elastic ( $r=0.993$ ) impact all closely estimated peak voltage.

## 5. Conclusions

The electro-acoustic device considered is sensitive to drop mass, velocity and shape. The observations reported here favor the concept that the acoustic impact

of water drops is of an inelastic nature, especially where the collapse of the drop tends to interfere with the natural motion of the target. Drops, however, appear to show varying degrees of inelasticity according to size. These observations were limited to relatively low impact velocities and it is possible that at high impact velocities, where drops may disintegrate in an explosive manner, a different type of relationship may exist.

This particular device has limitations for use as a disdrometer. Because of the duration of the decaying waveform, the pulses produced by the successive impacts of raindrops will tend to interfere with each other and the device can only be used at relatively low rainfall intensities. The decline in sensitivity of the transducer toward its edge also produces errors. A correction equation for this effect has been proposed by Cooper (1951). Also, ground-based instruments which infer drop size from the impact of the drop suffer errors through variations in drop velocity and angle of impact caused by vertical and horizontal air currents. However, such devices show some promise in determining rainfall energy relations.

## REFERENCES

- Cooper, B. F., 1951: A balloon-borne instrument for telemetering raindrop-size distribution and rainwater content of clouds. *Australian J. Appl. Sci.*, **2**, 43-45.
- Cunningham, R. E., 1951: Airborne raindrop-size measurement and instrumental techniques. Conference on Water Resources, Bull. 41, Illinois State Water Survey, 285-291.
- Imaynitov, L. M., V. V. Mikhaylovskaya and B. F. Etveev, 1966: Airborne and radiosonde instruments for measuring raindrop size. *Instruments and Methods for Meteorological Observation*, Israel Program for Scientific Translation, No. 1370, 283-291.
- Katz, I., 1952: A momentum disdrometer for measuring raindrop size from aircraft. *Bull. Amer. Meteor. Soc.*, **33**, 365-369.
- Laws, J. O., 1941: Measurement of fall velocity of water-drops and raindrops. *Trans. Amer. Geophys. Union*, **22**, 709-721.
- Mikhaylovskaya, V. V., 1964: Theory of measuring the size of raindrops by acoustic method. *Sov. Hydrol. Selected Papers*, No. 1, 85-90.
- Pfeiffer, A., 1963. A new method for high-speed motion-picture photography of transparent drops. *Appl. Opt.*, **2**, 1287-1293.