

A Calibration of the NCAR Acoustical Ice Nucleus Counter

ROGER L. STEELE

Colorado State University, Fort Collins

C. P. EDWARDS

E. Bollay Associates, Inc., Boulder, Colo.

LEWIS O. GRANT

Colorado State University, Fort Collins

AND GERHARD LANGER

National Center for Atmospheric Research, Boulder, Colo.

(Manuscript received 13 June 1967, in revised form 5 July 1967)

ABSTRACT

The NCAR acoustical ice nucleus counter was calibrated against a Bigg-Warner Weather Bureau type chamber modified as a mixing chamber. The mixing chamber was in turn calibrated against the CSU-NSF isothermal diffusion cloud chamber. This work was carried out using a 300-liter aluminized mylar bag into which known samples of silver iodide nuclei were introduced. Nuclei were transferred from the bag to the NCAR counter in a carrier gas, at a flow rate of 10 liters min^{-1} . It was found that the NCAR counter measured from 16–52% of the count given by the mixing chamber. An NCAR unit was modified with a velvet liner to test the feasibility of eliminating the glycol system, and measurements were made as described above. The modified unit did not count reliably.

1. Introduction

The counting of natural and artificial nuclei occurring in the atmosphere is a problem of major importance, since these nuclei are vital in certain precipitation processes. Many counting methods have been developed, the most common of which are listed below:

- 1) Expansion chamber (Bigg-Warner counter: Warner, 1957)
- 2) Mixing chamber (Bigg, 1957; Soulage, 1964)
- 3) Millipore filters (Bigg, 1963)
- 4) Sugar bubble (Bigg, 1965)
- 5) NCAR acoustical ice nucleus counter (NCAR counter: Langer *et al.*, 1967)
- 6) CSU-NSF isothermal cloud chamber (CSU chamber: Steele and Krebs, 1967)

All of the methods listed provide counts of ice crystals that have been formed by activated ice nuclei. However, difficulties are encountered in converting data to some standard criterion. All methods must necessarily rely on the ice nucleation process, but each method provides a different environment for ice crystal growth in terms of such important parameters as supersaturation, time and temperature, all of which affect the

nucleation process. It is therefore not surprising that the ice nucleus concentrations, as measured in the several devices, frequently disagree by as much as an order of magnitude.

Of these devices, the NCAR counter offers several advantages. The most important are continuous measurement, a range between 10^{-1} and 10^3 nuclei liter^{-1} , variable temperature, rapid response, and portability.

The purpose of this study was to correlate the performance of the NCAR counter with other established counting devices. The CSU chamber was chosen as the standard unit because it is a widely accepted instrument and probably most nearly models natural cloud processes. The mixing chamber used was a modified Bigg-Warner Weather Bureau type chamber. This was calibrated against the CSU chamber and was subsequently used to calibrate the NCAR counter.

It should be emphasized that the evaluations in this paper are based upon an artificial source of nuclei. Counting characteristics for natural nuclei will be covered in a companion paper.

2. Description of the NCAR counter

a. Mechanical features. The nucleus counter (Langer *et al.*, 1967) developed at NCAR and made commercially

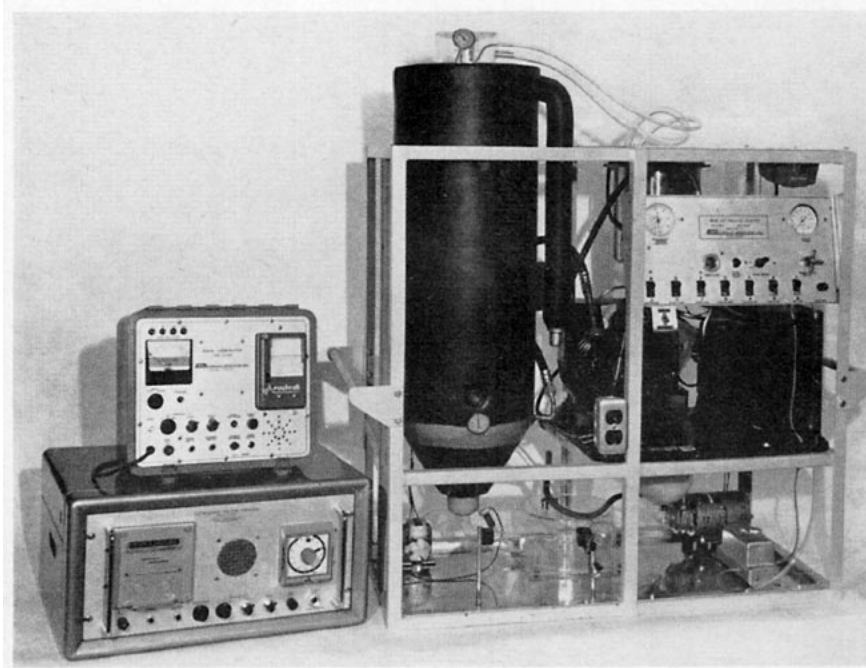

FIG. 1. NCAR-Bollay counter with digital printer and rate computer.

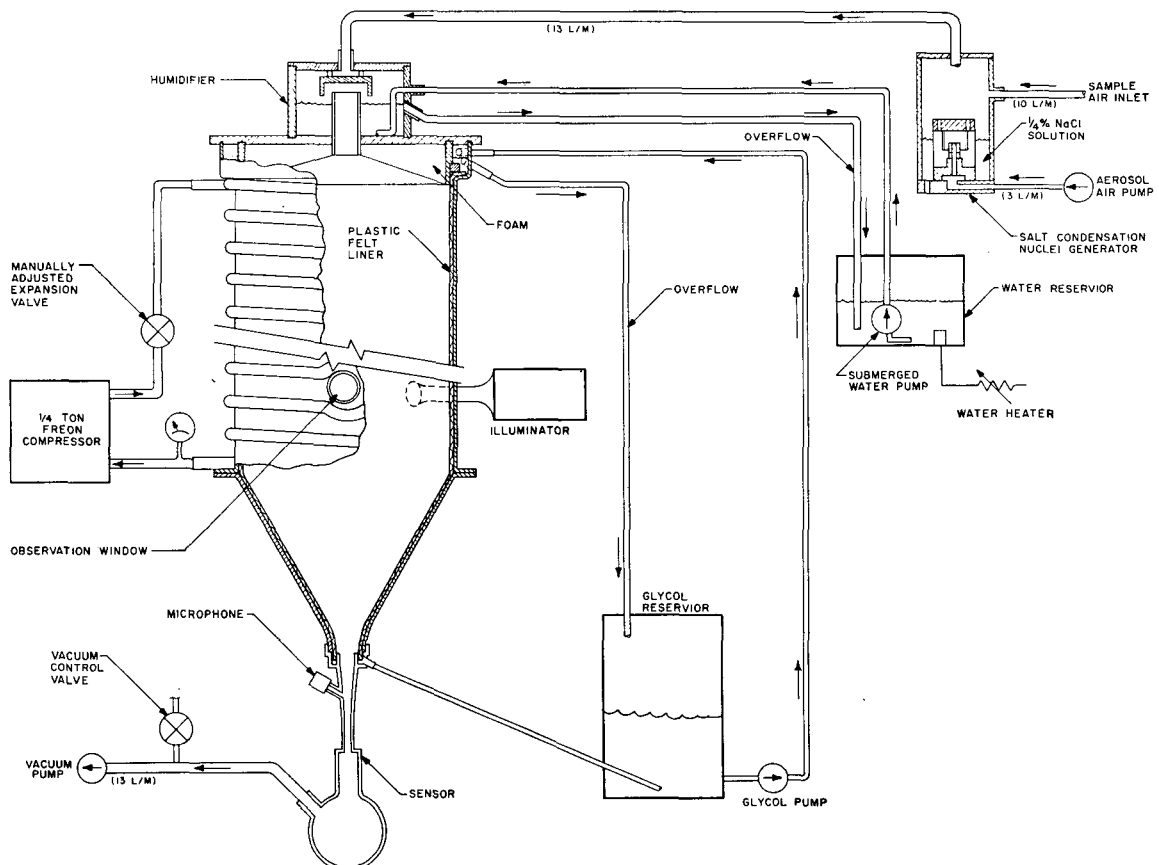

FIG. 2. Schematic diagram of NCAR ice nucleus counter.

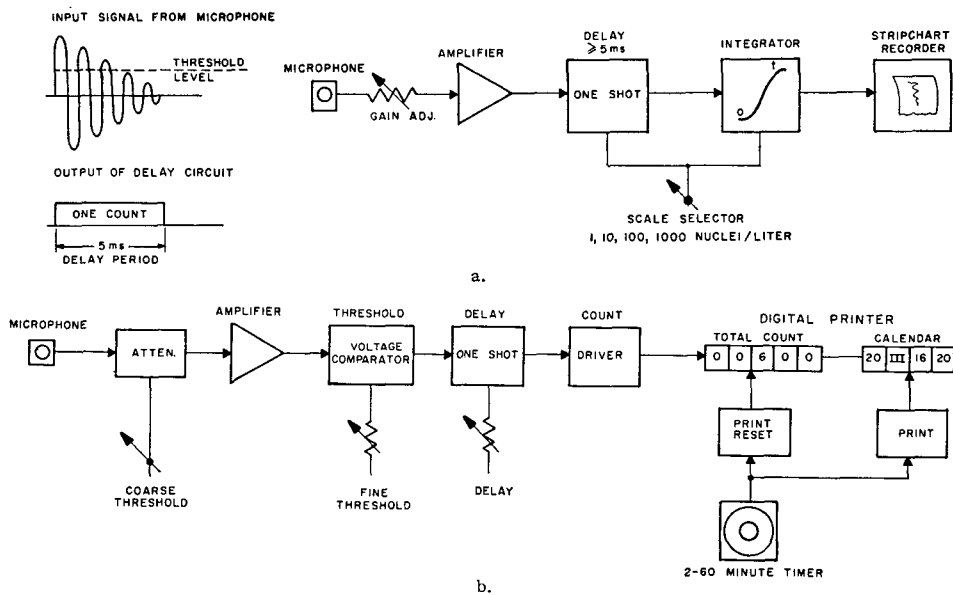

FIG. 3. Simplified diagram of rate meter, a., and totalizing printer, b.

by E. Bolly Associates, Inc., uses an acoustic particle counter as a detector (Langer, 1965, 1966¹). The air sample from which an ice nucleus count is desired is humidified and cooled to form a supercooled fog in a refrigerated chamber which is lined with plastic foam through which glycol is circulated. The system is depicted in Figs. 1 and 2. The acoustic sensor at the outlet of the cooling chamber detects only those particles larger than 20–30 μ , and is thus insensitive to the large number of water droplets present ($<20 \mu$) but not to the much larger ice crystals which are formed in the supercooled fog.

The pump which induces air flow from the chamber through the acoustic sensor provides a flow of 13 liters min^{-1} . The volume of the cooling chamber is large enough to provide a nominal 1.5-min residence time for ice crystal growth. About 3 liters min^{-1} of the total flow is directed through a sodium chloride aerosol generator to provide condensation nuclei. If adequate numbers of these nuclei are not provided, some of the droplets grow large enough to set off the sensor. The aerosol generator can be shunted when sampling is done near highly populated areas where the supply of condensation nuclei is copious.

b. Electronic features. A microphone is used to detect the acoustical signal generated by the crystals passing through the sensor. The output of the microphone can be connected to several electronic readout systems (designed by E. Bolly Associates, Inc.), two of which are shown in Fig. 1. Schematics are shown in Figs. 3a and 3b. The rise time of the acoustical signal from the sensor is much faster than the response of the present

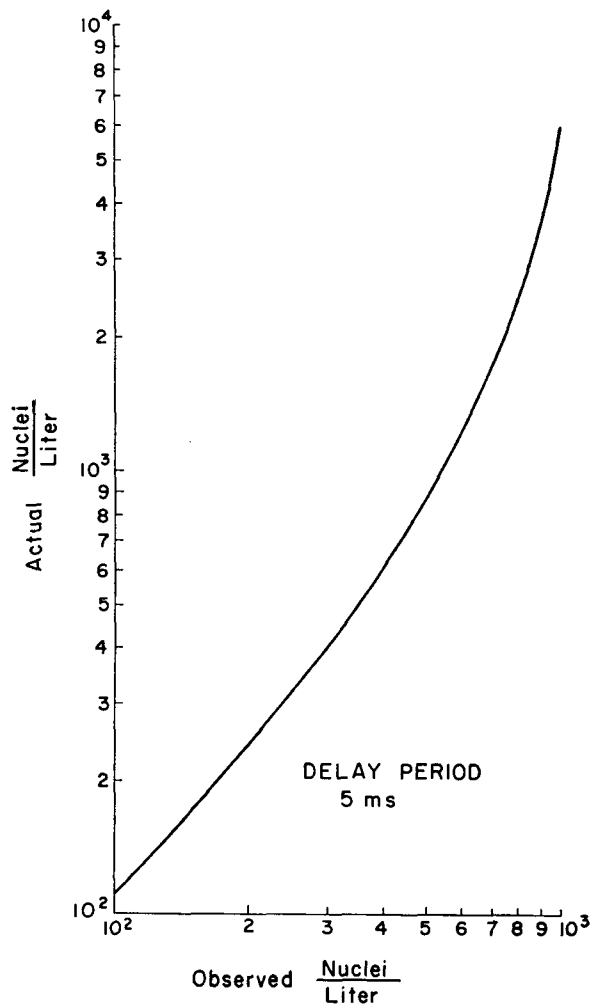

FIG. 4. Delay time correction curve for acoustical counter.

¹ Langer, G., 1966: A further development of an acoustic particle counter. Paper presented at Fifth Annual Meeting of the Amer. Assoc. for Contamination Control, Houston, Tex.

microphone. As a result, the microphone rings at its resonance frequency and produces a damped sine wave at approximately 2 kHz. A delay, or dead time, of approximately 5 msec is therefore required to insure that the amplitude of this wave has diminished to 10% of its initial value. This will then avoid counting a crystal more than once. The effect of the delay period on counting precision is shown on Fig. 4.

The most straightforward readout system which incorporates the above feature is a rate meter, shown in simplified form in Fig. 3a. The output of the microphone is connected through a gain control to a voltage amplifier. The output of the amplifier triggers a one-shot delay circuit. This output is then integrated to provide a dc-voltage analog of the count rate, which is in turn printed out on a strip chart recorder.

The rate meter provides for four scales on the recorder, of 1, 10, 100 and 1000 nuclei liter⁻¹. These correspond to 10, 100, 1000 and 10,000 counts min⁻¹ at a 10 liter min⁻¹ sample air flow rate.

Another readout system, shown in Fig. 3b, processes the input signal in a similar fashion; however, the output of the delay circuit is totalized with a mechanical counter and printed on paper tape with month, day, hour and minute information. The totalizing period can be adjusted between 2 and 60 min. A third system, with automatic range switchings, has been employed in aircraft plume tracking experiments (Langer *et al.*, 1967).

All of the readout systems require a correction when counting at rates above 10² nuclei liter⁻¹, to take into account the dead time resulting from the 5-msec delay referred to above. It should be emphasized that this delay, necessary because of the limited response of the microphone, does not represent a basic sensor restriction; improved microphones are currently being investigated so that the counting rate can be extended.

3. Modification of the NCAR counter

The NCAR counter has certain disadvantages. Among these is the glycol system mentioned above, which is used to prevent frosting on the chamber walls (Langer *et al.*, 1967). Elimination of this system is desirable since it can produce operating difficulties, i.e., a glycol flow which is too low permits frosting due to non-uniform distribution in the foam and a flow which is too high will flood the sensor.

It was therefore decided to determine if the glycol system could be replaced with a velvet liner. The velvet was mounted a short distance from the wall, as is customary in mixing chambers, to minimize frosting. This arrangement permits vapor transport to the metal (brass) walls but separates the supercooled water droplets from the incoming air and vapor within the working volume. The velvet normally then minimizes frosting in the volume under study, so that droplet-vapor metastable equilibrium is maintained and nucleation

from extraneous ice is minimized. Such a system should compare with the glycol system described above.

4. Selection of a standard for calibration

The ice nucleus counts from the NCAR acoustical counter must be related to data from other counters if they are to be generally useful. Relative counts of ice nuclei in the atmosphere are sufficient in certain circumstances, while in others it is desirable to know the absolute concentrations.

The absolute concentration, however, cannot yet be measured directly. Several of the methods for counting nuclei introduce environmental factors not representative of the natural environment, such as temperature history, degree of supersaturation, residence time and wall effects.

These factors should be controlled in selecting a standard for calibration of a counter. The CSU-NSF isothermal chamber was chosen (Steele and Krebs, 1967) since the above factors are closely controlled. Supersaturation closely approximates that in a natural cloud, since the artificial cloud is pre-cooled to within a few degrees of the chamber temperature before it is introduced. Thermal shock is minimized due to the large volume and the absence of any rapid expansion. Residence time is not a factor since the nuclei can be held in a given environment indefinitely. Wall effects are minimized due to the large volume (3 m³) and near unity height-to-diameter ratio. This geometry yields a low surface-to-volume ratio. The CSU chamber is in common use as a standard to calibrate ice nucleus generators used by various federal, state and private agencies (Grant and Steele, 1966).

5. Calibration procedures

The NCAR counter normally samples 10 liters min⁻¹ of atmospheric air for subsequent counting of the ice crystals at concentrations up to 500 liter⁻¹. Normal atmospheric concentrations of ice nuclei are too low for direct counting in the CSU chamber. Furthermore, these concentrations in the atmosphere vary with time, so the trends are uncertain. To overcome this difficulty, it was decided to supply both sensors with controlled concentrations of artificial nuclei (AgI).

The generator used for the nucleus source was the CSU modified Skyfire (Steele and Sciacca, 1966). The effectiveness of this generator is relatively uniform with respect to temperature in the temperature range used, i.e., less than 15% change (°C)⁻¹. Therefore, due to statistical variations in generator performance, no corrections were made for this effect.

Measurements of the overall collection efficiency using artificial nuclei also presents a problem with the CSU chamber; about 8 × 10⁶ active nuclei are required for a statistically significant measurement, and this large number is not compatible with the capacity of the

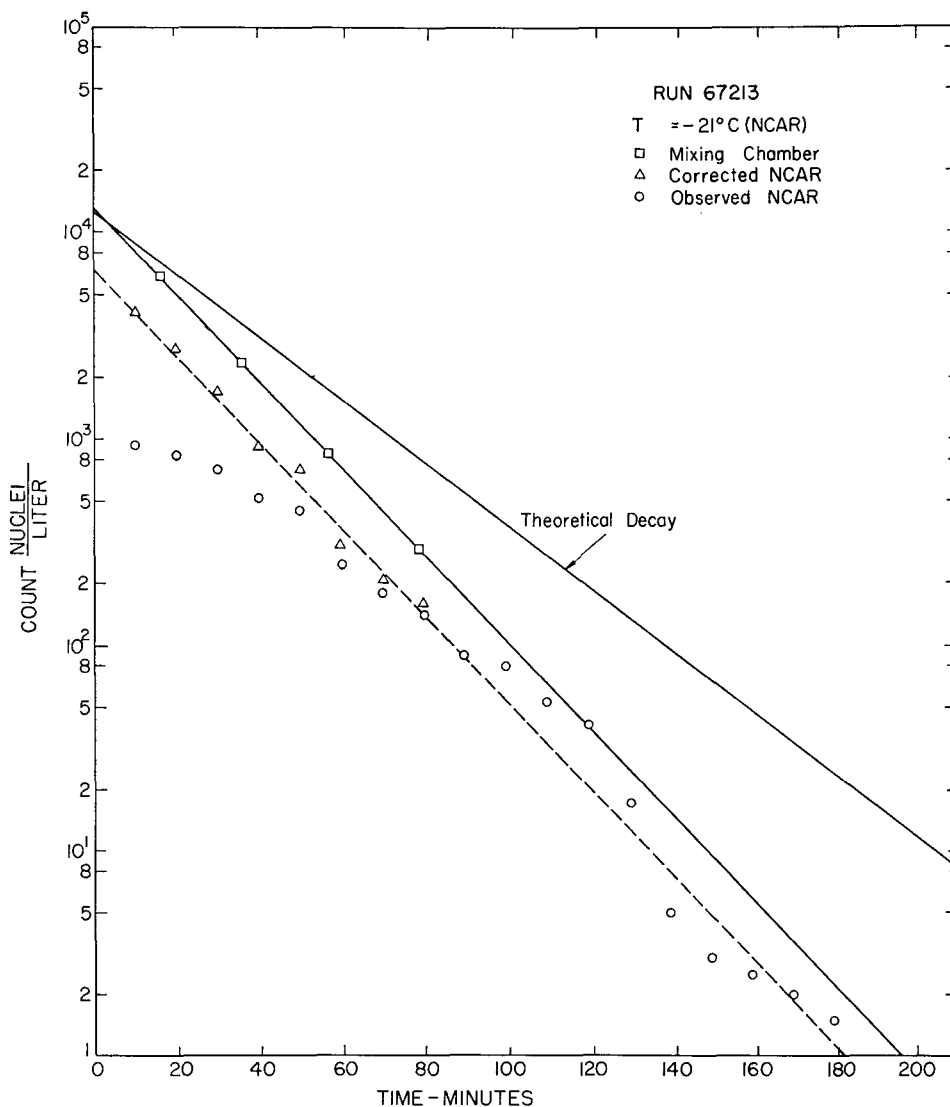

FIG. 5. Nucleus concentration as measured by mixing chamber and NCAR counter from 300-liter aluminized mylar bag source.

acoustical sensor which is about $500 \text{ nuclei liter}^{-1}$ or $5 \times 10^3 \text{ counts min}^{-1}$.

This problem was overcome by utilizing a 300-liter aluminized mylar bag coupled with a U. S. Weather Bureau Bigg-Warner expansion chamber modified for use as a mixing chamber, and calibrated against the isothermal chamber.² A sample of nuclei is inserted into the bag and withdrawn at the rate of $10 \text{ liters min}^{-1}$ for processing in the acoustical chamber. The air withdrawn from the bag is replaced by a $10 \text{ liter min}^{-1}$ flow of dry nitrogen (dew point, -50C).

² Attempts to use the Bigg-Warner expansion process failed because the pump became quickly contaminated with silver iodide and generated ice nuclei on its own. Attempts to pressurize the chamber with humidified nitrogen failed. The counts were very low, for unknown reasons.

With the above factors in mind, the sample was introduced into the bag as follows: A nucleus sample was taken from a dilution tunnel, which was supplied with nuclei from the generator. The sample was further diluted via dynamic dilution, as needed, before introduction into the mylar bag (Grant and Steele, 1966) by means of a 30-cc hypodermic syringe. It was then mixed well before introduction into the NCAR counter inlet as described above. The sample concentration was controlled by dilution so that it would be about 10^3 – $10^4 \text{ nuclei liter}^{-1}$. The inlet to the NCAR counter was sampled periodically and measured in the mixing chamber. Details of this process will be discussed later.

Nucleus depletion and the decay due to aggregation and wall diffusion reduce the nucleus concentration in the mylar bag. No nuclei are supplied by the nitrogen

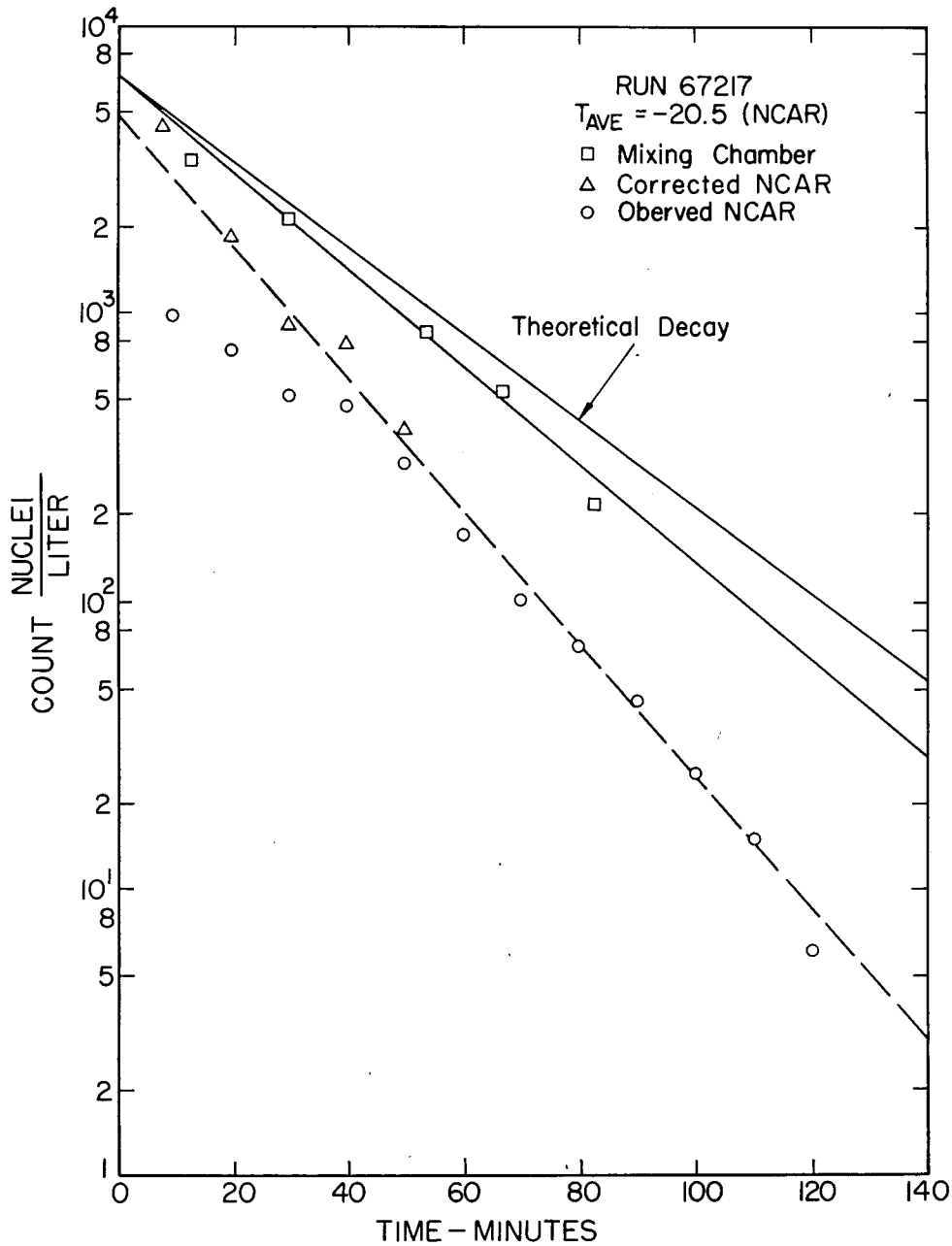

FIG. 6. Nucleus concentration as measured by mixing chamber and NCAR counter from 300-liter aluminized mylar bag source.

flow which replaces the air withdrawn from the bag. The theoretical depletion is easily determined by the familiar rate equation

$$\frac{dC}{dt} = -\frac{\dot{V}}{V}C,$$

where C is the total number of nuclei in the chamber at time t , \dot{V} the effluent flow rate, and V the holding chamber volume. The integrated form of this equation is

tion is

$$\frac{C}{C_0} = e^{-(\dot{V}/V)(t-t_0)},$$

where C_0 is the initial concentration and t the time.

The actual decay and/or depletion was measured by taking periodic samples from the supply line to the NCAR counter with a 60-cc syringe. These samples were processed in the mixing chamber as follows: The

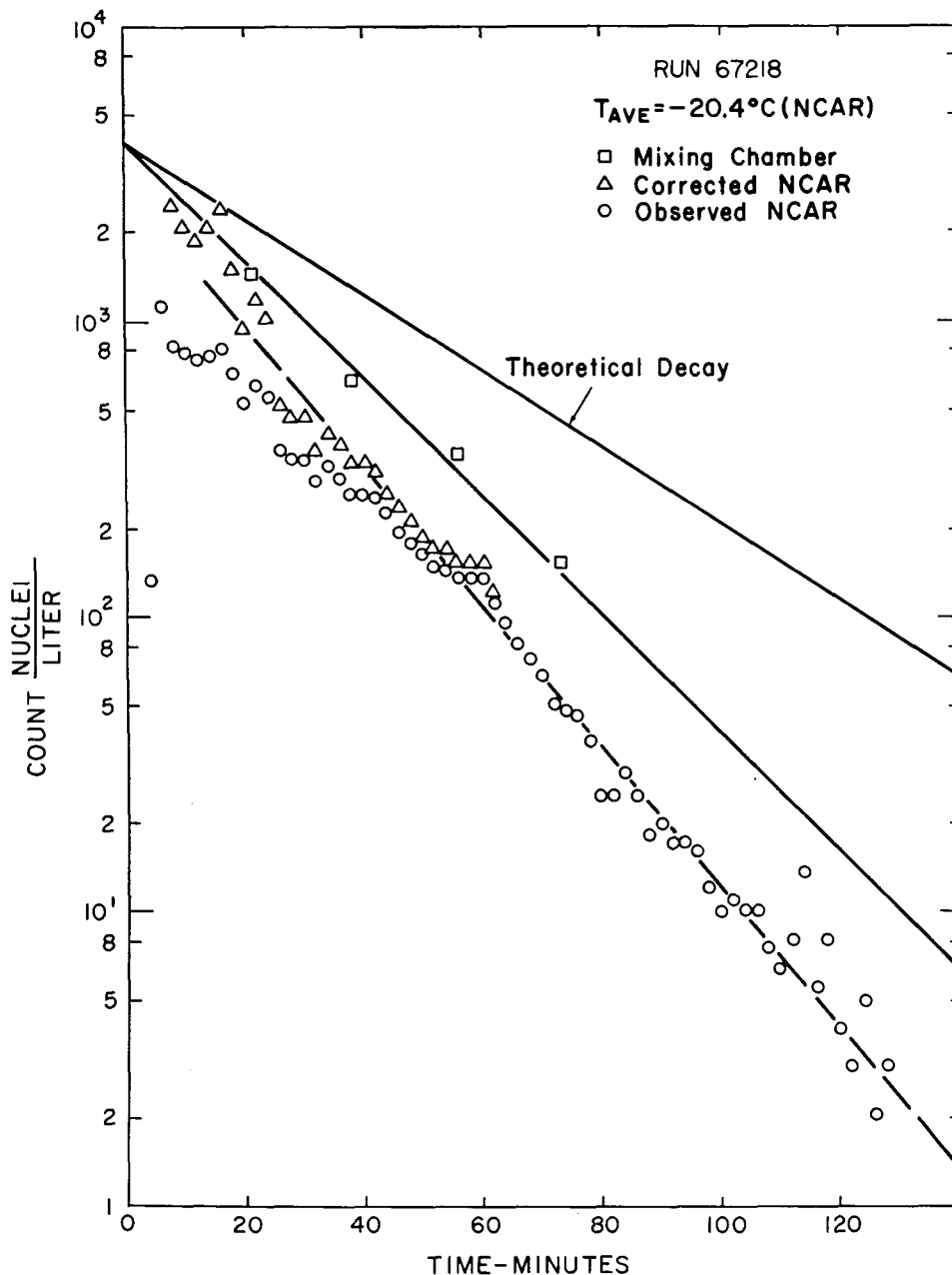

FIG. 7. Nucleus concentration as measured by mixing chamber and NCAR counter from 300-liter aluminumized mylar bag source.

hinged, pressure-sealed lid was replaced with a lucite plate, and drilled to accommodate thermometers and a tube for delivery of sugar solution to the tray supplied with the unit. The pump for pressurizing the chamber was disconnected and a regulated nitrogen supply was connected to the unit in its place, for use in purging the chamber of natural nuclei before insertion of a sample from the mylar bag.

The mixing chamber was operated at a wall temperature of -25C to provide an air temperature of -22C

approximately 3 mm from the walls during the actual nucleus measurement. The sugar solution was added to the tray just before a test, at room temperature to avoid initial crystallization in the tray. After the sugar solution had cooled to below -5C (about 3 min), a 60-cc sample was introduced from the mylar bag. Crystals appeared almost at once with the nucleation and settling process being complete in about 2 min. Crystals, when counted, were used to determine the actual concentration of nuclei in the bag at the time of

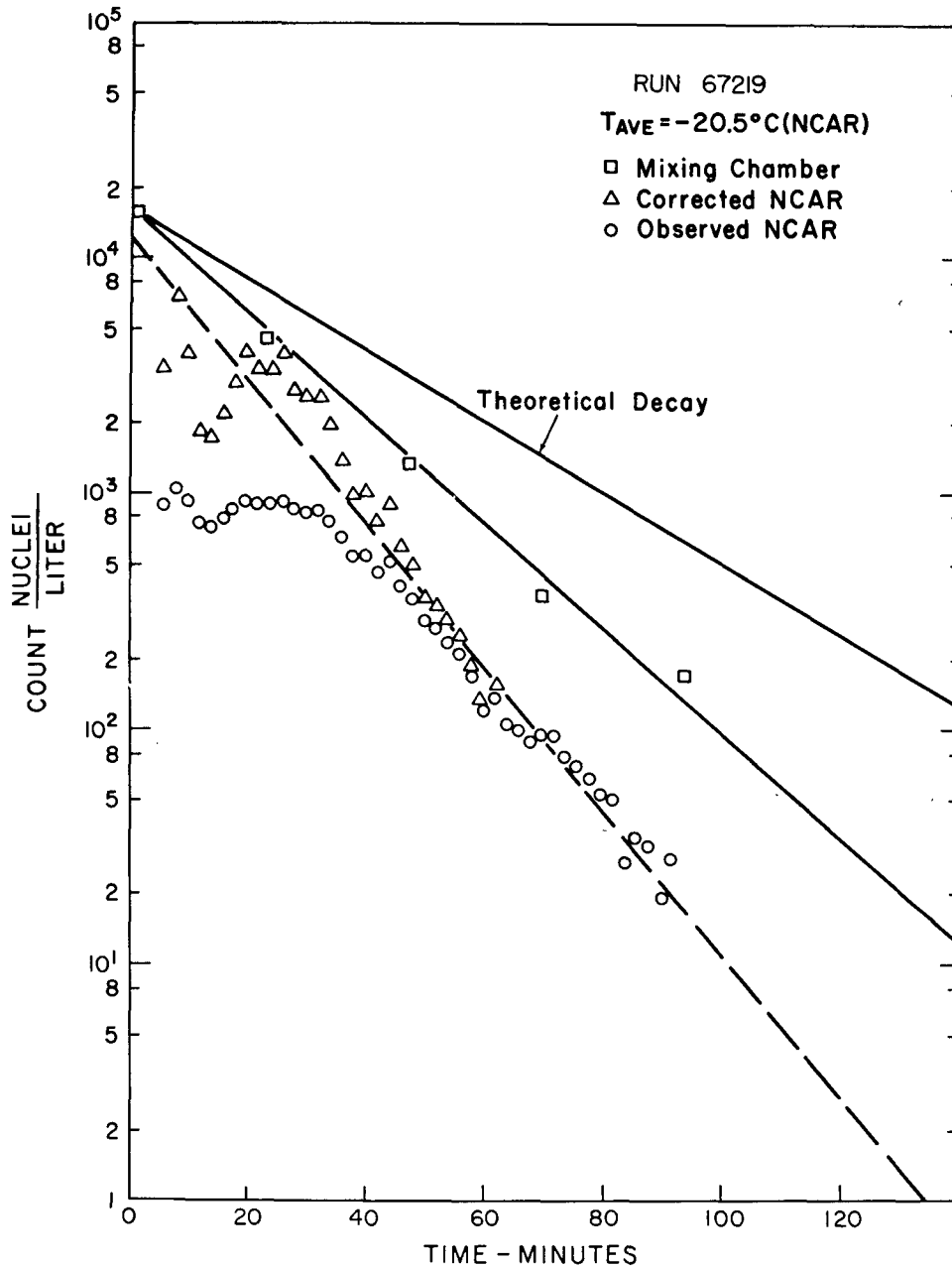

FIG. 8. Nucleus concentration as measured by mixing chamber and NCAR counter from 300-liter aluminumized mylar bag source.

sampling. Additional measurements were made periodically during a run; results are plotted in Figs. 5-9. The theoretical depletion is also shown.

It was impractical to maintain precise control of flow rates to and from the mylar bag, which partially explains the different slopes in the figures. This effect is better illustrated in Fig. 10. The deviation from the theoretical decay curve is due to loss of particles to the walls. Squires (1966) has shown that the wall loss to this type of mylar bag averages $10\% \text{ hr}^{-1}$ for cloud

nuclei and $40\% \text{ hr}^{-1}$ (but variable) for Aitken nuclei. Our results fall in the region of those for Aitken nuclei, which have the same general particle sizes as silver iodide aerosol from a Skyfire generator. Aggregation should not be a factor since the initial concentrations are 10 particles cc^{-1} or less.

The background count in the mixing chamber was checked before each run, and reduced to zero by nitrogen purging. Sufficient moisture levels were provided by the relatively warm sugar solution and a wetted paper

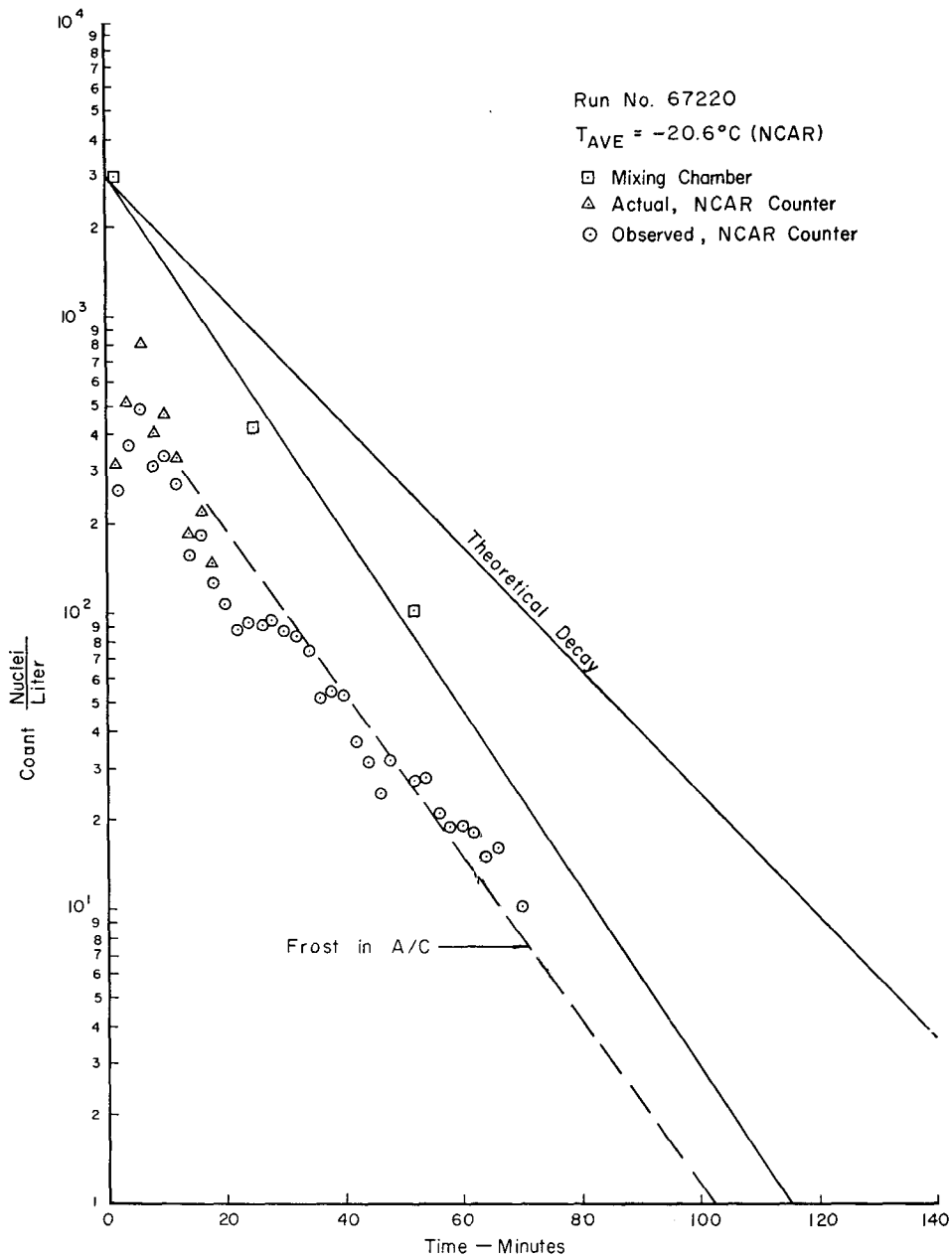

FIG. 9. Nucleus concentration as measured by mixing chamber and NCAR counter from 300-liter aluminumized mylar bag source.

pad taped to the lucite cover. A cloud of water droplets was observed in the chamber throughout the run.

In order to get a direct comparison of the mixing chamber with the CSU chamber, it was necessary to introduce about 10^6 nuclei into the mixing chamber. A stack of microscope slides was substituted for the sugar solution and provision was made for additional moisture from a hand-operated nebulizer fitted with a selective filter, which passed drops smaller than about 20μ in diameter. Counts were made using the same pro-

cedure as in the CSU chamber. The resulting average nucleus concentrations of six duplicate comparative tests were as follows:

- Bigg-Warner chamber: 3.2×10^5 nuclei cc^{-1}
- Isothermal chamber: $4.1 < 10^5$ nuclei cc^{-1}

It is seen that the mixing chamber averaged about 78% of the values given by the CSU chamber at -22°C . This is as good as can be expected (Grant and Steele,

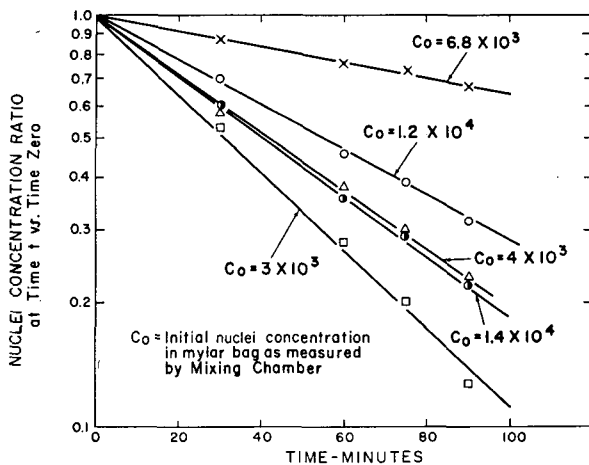

FIG. 10. Combined decay curves of nuclei concentration ratios.

1966). Similar agreement has been obtained in the past with a standard "deep freeze" used as a mixing chamber.

6. Performance of modified NCAR counter

The velvet-lined unit does not perform satisfactorily. Wall effects are pronounced and it is not possible to maintain a cloud by means employed in the glycol model (Langer³). The only way an adequate cloud could be maintained was through the use of steam as the source. It is estimated that the velvet-lined unit required 10 times the moisture that the glycol unit required for about the same cloud density.

The large moisture requirement of the velvet-lined unit rendered its use as a pre-cooler for the acoustical sensor impractical. The unit frosted much too rapidly, and produced extraneous nuclei at a rate of 15 nuclei liter⁻¹ soon after it reached operating temperature.

This concludes the discussion of the modified unit. The negative results are presented only to point out our failure to eliminate the glycol system. The operating and logistical problems required by it are indeed a necessity. The use of velvet as a cloud chamber liner is restricted to chambers with large volume-to-surface ratios, that are not operated with a cloud present continuously for long periods of time. No difficulty is encountered in the velvet-lined CSU chamber, for example.

7. Results—NCAR counter

The results of five nucleus calibration tests for the NCAR counter, at 5000 ft laboratory elevation, are shown in Figs. 5–9. The data are plotted as measured by the mixing chamber and by the NCAR counter. The mixing chamber was calibrated against the CSU chamber as described above. The mixing chamber readings were taken at about -22°C ; the NCAR counter data were taken at about -21°C .

³ Langer, G., *op. cit.*

TABLE 1. Count ratio of ice nuclei concentrations given by the NCAR counter to that given by the mixing chamber.

Run no.	Count ratio		
	5×10^2 liter ⁻¹	10^2 liter ⁻¹	10 liter ⁻¹
67213	0.51	0.52	0.53
67217	0.58	0.16	—
67218	0.46	0.35	0.24
67219	0.22	0.20	—
67220	0.23	0.28	0.37
Extremes referred to mean	1.50 max 0.68 min	1.73 max 0.53 min	1.40 max 0.63 min
Normalized extremes referred to mixing chamber	0.45 max 0.20 min	0.52 max 0.16 min	0.42 max 0.19 min

The measurements shown on the curves of the NCAR counter, when compared to the mixing chamber, are fairly consistent, except that counts above 500 liter⁻¹ are subject to error due to the electronic constraint in the microphone discussed in Section 2b. The effect of this error is shown in Fig. 4. The plots in Figs. 5–9 show the corrected curves. The data from the NCAR counter correlate well with the mixing chamber measurements, especially if the corrected portions of the curves are ignored. Rather poor correlation occurred in the 10–100 liter range for run no. 67213, Fig. 5, probably because of frost accumulation in the NCAR counter. Such frost will spall off and give spurious counts; the chamber should be checked for frost every 6–8 hr.

Data from all of the runs are summarized as follows: The count ratio shown in Table 1 is defined as the ratio of concentration given by the NCAR counter to that given by the mixing chamber. These are shown at concentrations of 500, 100 and 10 nuclei liter⁻¹. The mean count ratio is shown, along with the error range normalized to the mean and to the mixing chamber. The mean of all runs referred to the mixing chamber is 0.36, while the median is 0.35. The standard deviation is 0.15.

As may be seen in Table 1, the NCAR counter consistently counted 16–52% of the nuclei registered by the mixing method. This level of agreement is sufficient for most ice nucleus measurement requirements encountered in the field or laboratory. The method is believed superior to other continuous counters in use, considering all factors. From these results, it appears that the collection efficiency of the NCAR chamber is quite good. The spread in observations may be related to variations in the flow regime in the NCAR counter chamber or to changing nucleation conditions from run to run in the mixing chamber. These variations have also been observed under certain field conditions (Langer *et al.*, 1967; Grant *et al.*, 1967). This problem, along with altitude effects, is under study.

8. Summary and conclusions

A general method has been developed for calibrating ice nucleus counters, in particular the NCAR acoustical

counter. It permitted calibration of two types of NCAR counters, one employing velvet and the other glycol to control frost.

The velvet-lined NCAR counter gave unusable results. The NCAR glycol model is applicable throughout the range of 1–500 nuclei liter⁻¹ with a mean difference of 34% of mixing chamber counts. It is thus a suitable measuring device for field measurements of ice nuclei, assuming that the laboratory work models field conditions. It is also a practical device since it samples continuously, is readily portable, and can be operated for reasonably long periods of time without the attention of an operator.

Acknowledgments. The authors are indebted to the National Science Foundation and to the U. S. Bureau of Reclamation, who sponsored the research; and to T. O. Steele of E. Bollay Associates, Inc., and W. Procter of Colorado State University, who helped gather and reduce much of the data.

REFERENCES

Bigg, E. K., 1957: A new technique for counting ice-forming nuclei in the atmosphere. *Tellus*, **9**, 394.

—, 1963: The measurement of ice nucleus concentration by means of Millipore filters. *J. Meteor.*, **2**, 266–269.

—, 1965: Problems in the distribution of ice nuclei. *Proc. Intern. Conf. Cloud Physics*, Tokyo, Japan, 137–140.

Grant, L. O., and R. L. Steele, 1966: The calibration of AgI generators. *Bull. Amer. Meteor. Soc.*, **47**, 713–717.

—, C. P. Edwards and Roger Reinking, 1967: Ice nuclei and other studies of opportunity during the 1967 Yellowstone Expedition. *Proc. 1967 Yellowstone Expedition*, State University of New York, Albany.

Langer, G., 1965: An acoustic particle counter—preliminary results. *J. Colloid Sci.*, **20**, 602–609.

—, J. Rosinski and C. P. Edwards, 1967: A continuous ice nucleus counter—its application to tracking in the troposphere. *J. Appl. Meteor.*, **6**, 114–125.

Soulage, G., 1964: Un analyseur de pouvoir glaciogène simple pour un réseau de stations de mesure. *J. Rech. Atmos.*, **1**, 95–100.

Squires, P., 1966: An estimate of the anthropogenic production of cloud nuclei. *J. Rech. Atmos.*, **2**, 297–308.

Steele, R. L., and F. W. Sciacca, 1966: Characteristics of AgI ice nuclei originating from anhydrous NH₃-AgI complexes. Pt. 2. *J. Rech. Atmos.*, **2**, 315–326.

—, and F. W. Krebs, 1967: Characteristics of AgI ice nuclei originating from anhydrous NH₃-AgI complexes. Pt. 1. *J. Appl. Meteor.*, **6**, 105–113.

Warner, J., 1957: An instrument for the measurement of freezing nucleus concentration. *Bull. Obs. Puy de Dôme*, **2**, 33–46.