

A Comparison of Directional Buoy and Fixed Platform Measurements of Pacific Swell

W. C. O'REILLY

Center for Coastal Studies, Scripps Institution of Oceanography, La Jolla, California

T. H. C. HERBERS

Department of Oceanography, Naval Postgraduate School, Monterey, California

R. J. SEYMOUR* AND R. T. GUZA

Center for Coastal Studies, Scripps Institution of Oceanography, La Jolla, California

(Manuscript received 31 October 1994, in final form 28 June 1995)

ABSTRACT

The performance of the Datawell Directional Waverider and the National Data Buoy Center (NDBC) 3-m discus buoy, widely used to measure the directional properties of surface gravity waves, are evaluated through comparisons to an array of six pressure transducers mounted 14 m below the sea surface on a platform in 200-m depth. Each buoy was deployed for several months within a few kilometers of the platform. The accuracy of the platform ground-truth array was verified by close agreement of wavenumber estimates with the theoretical linear dispersion relation for surface gravity waves. Buoy and array estimates of wave energy and directional parameters, based on integration of the directional moments across the frequency band of energetic swell (0.06–0.14 Hz), are compared for a wide range of wave conditions. Wave energy and mean propagation direction estimates from both buoys agree well with the platform results. However, the Datawell buoy provides significantly better estimates of directional spread and skewness than the NDBC buoy.

1. Introduction

Buoys are widely used to measure the directional properties of surface gravity waves in deep and intermediate water depths. A 3-m discus buoy developed by the National Data Buoy Center (NDBC) is the principal source of offshore directional wave measurements along U.S. coastlines. This buoy uses a Hippy 40 heave-pitch-roll sensor (manufactured by Datawell) to estimate sea surface displacement and the north-south and east-west components of sea surface slope. Datawell has also manufactured a widely used 0.9-m sphere "Directional Waverider" buoy since the late 1980s. The directional information provided by the Datawell and NDBC buoys is theoretically equivalent, but the Datawell buoy uses horizontal translations, measured with a combination of the Hippy 40 and fixed accelerometers, rather than sea surface slopes. Pitch-roll systems are sensitive to trim errors and have

low signal-to-noise ratios when measuring small sea surface slopes, whereas translational systems are more sensitive to restriction of their horizontal movement by mooring line forces.

Both buoys have been tested extensively in the laboratory (e.g., Steele et al. 1992), but comparisons to fixed-platform ground-truth measurements in deep water are scarce. In the WADIC study (Allender et al. 1989), several directional buoys were compared to fixed-platform measurements in the North Sea. However, NDBC 3-m discus buoys were not yet in use, and the Datawell buoy (WAVEC) was an older pitch-roll design. Anctil et al. (1993) recently compared NDBC 3-m discus buoy measurements to a PUV gauge (pressure and the two components of horizontal velocity) attached to a deep water platform in the Gulf of Mexico. The Allender et al. (1989) and Anctil et al. (1993) studies report significant discrepancies between buoy and platform measurements. The accuracy of the single PUV platform ground truth in the Anctil et al. study is unknown. Various platform instruments were used in the WADIC study to generate a best estimate ground-truth dataset, but no detailed confirmation of ground-truth accuracy was presented. Both studies focus on energy and directional parameters at the peak wave frequency, leading to significant statistical uncertainty in some of the resulting comparisons.

* Additional affiliation: Offshore Technology Research Center, Texas A&M University, College Station, Texas.

Corresponding author address: Dr. W. C. O'Reilly, Civil Engineering, University of California at Berkeley, 412A O'Brien Hall, Berkeley, CA 94720-1712.
E-mail: bor@nene.berkeley.edu

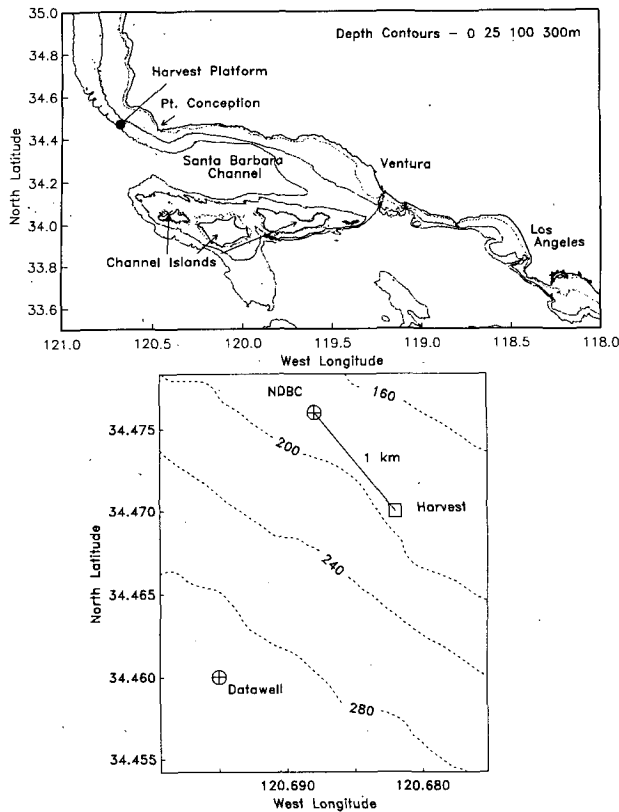

FIG. 1. Location of Harvest Platform (upper panel) and the nearby directional buoys (lower panel). Dashed contours indicate depths in meters.

In the present study, directional wave data from a Datawell Directional Waverider and an NDBC 3-m discus buoy are compared to accurate and statistically stable ground-truth data from a nearby platform-mounted array of pressure sensors. The deep water and moderate current conditions at the platform are similar to those in a recent buoy-buoy intercomparison study in the northeast Atlantic (Barstow and Kollstad 1991). The Pacific Ocean swell in the present study has dominant periods longer than those typically found in North Sea and Gulf of Mexico verification studies. The experiment is described in section 2. The methods used to process the Datawell and NDBC buoy data are outlined in section 3. The accuracy of the platform array data is demonstrated in section 4. Buoy and array estimates of wave energy, mean propagation direction, and other directional parameters are compared in section 5, followed by a discussion and summary in section 6.

2. Experiment

A directional array of six Sensotec pressure transducers was deployed 14 m below sea level (186 m above the sea floor) on Texaco's Harvest Platform, 10 km west of Point Conception, California, (upper panel,

Fig. 1) in November 1992, as part of the Coastal Data Information Program (CDIP, Seymour et al. 1985, 1993). The platform is exposed to both the northern and southern Pacific Ocean swell. The sensors were placed at least 2.5 m away from the 1.6-m-diameter pilings, and the array has numerous redundant lags (Fig. 2) that were used to verify that the tower structure caused minimal flow distortion of the wave field at the frequencies of ocean swell (section 4). Every 3 h, a 2-h 17-min-long data record (sampled at 1 Hz) was transferred via telephone to CDIP's facility at the Scripps Institution of Oceanography. The pressure data were converted to surface elevation using linear theory and reduced to a cross-spectral matrix with approximately 0.01-Hz frequency resolution.

An NDBC 3-m discus buoy was deployed 1 km northwest of the platform from mid-December 1992 to mid-May 1993, and a Datawell Directional Waverider buoy was located 2 km southwest of the platform from mid-May 1993 to mid-August 1993 (lower panel, Fig. 1). Directional wave data from the NDBC buoy, archived by the National Ocean Data Center (NODC), consists of approximately 20-min-long data records collected hourly and reduced on board to a cross-spectral matrix with 0.01-Hz resolution in the 0.03-0.35-Hz frequency range. NDBC corrects the cross spectra

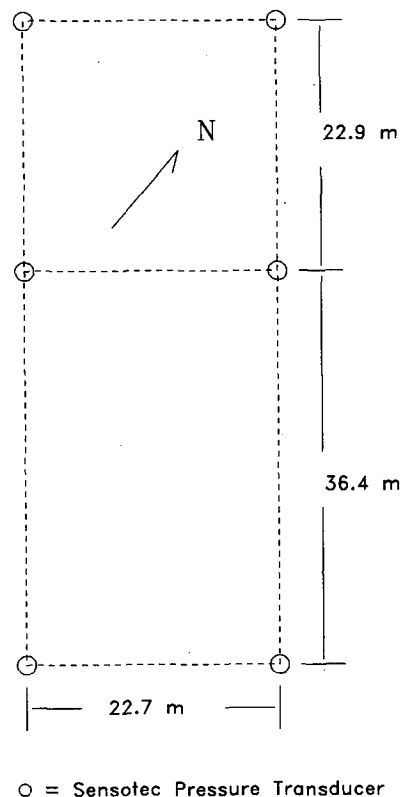

FIG. 2. Geometry of six-element pressure transducer array on Harvest Platform, mounted approximately 14 m below mean sea level.

for hull-mooring response and provides the first four directional Fourier coefficients (a_1, b_1, a_2, b_2 , see section 3) for each frequency band as two directional vectors (Steele et al. 1992).

The Datawell Directional Waverider collects approximately 26-min data records each half-hour. Cross-spectra with 0.005-Hz resolution in the frequency range 0.03–0.10 Hz, and 0.01-Hz resolution in the range 0.11–0.59 Hz, are computed on board and reduced to wave energy density, mean direction, spread, and a_2 and b_2 . Each half-hour the Datawell buoy transmits the three displacement time series from the previous half-hour only once, and the reduced spectral parameters seven to eight times (to minimize spectral data loss). The Datawell buoy was moored with a standard Datawell double rubber cord, and the data were transmitted to Vandenberg Air Force Base, California.

To reduce statistical uncertainty, the analysis was based on a complete 2-h 17-min platform array data record and the three NDBC or five Datawell runs that aligned most closely in time with this record (Fig. 3). The comparisons are restricted to the swell band (0.06–0.14 Hz) where the wave field is generally stationary for several hours (Elgar and Seymour 1985). Comparisons at sea frequencies were not possible, because these higher-frequency waves are spatially undersampled by the platform array. Because the buoys were 1–2 km (i.e., several wavelengths) away from the platform, the buoy and array data records are expected to be statistically independent realizations, and precise temporal overlap is not critical. The estimates of wave energy and directional moments in section 5 are based on integrations over the swell frequency band and have effective degrees of freedom that ranged from 400 to over 1000 (using platform array data). Because the NDBC buoy record lengths are roughly half those of the Datawell buoy and platform array, the NDBC estimates have lower effective degrees of freedom. Therefore, slightly more scatter is expected in the NDBC–array comparisons than in the Datawell–array comparisons.

3. Buoy data analysis

The wave energy spectral density $E(f)$, and the four lowest Fourier coefficients $a_1(f), b_1(f), a_2(f), b_2(f)$ of the directional distribution of wave energy, $D(\theta; f)$, at frequency f ,

$$a_1(f) = \int_0^{2\pi} d\theta \cos\theta D(\theta; f) \tag{1a}$$

$$b_1(f) = \int_0^{2\pi} d\theta \sin\theta D(\theta; f) \tag{1b}$$

$$a_2(f) = \int_0^{2\pi} d\theta \cos 2\theta D(\theta; f) \tag{1c}$$

$$b_2(f) = \int_0^{2\pi} d\theta \sin 2\theta D(\theta; f) \tag{1d}$$

are related to the buoy heave, pitch, and roll (or equivalently, heave, east–west horizontal translation, and north–south horizontal translation) cross-spectra:

$$\begin{aligned} E(f) &= C_{11}(f) \\ a_1(f) &= \frac{Q_{12}(f)}{\{C_{11}(f)[C_{22}(f) + C_{33}(f)]\}^{1/2}} \\ b_1(f) &= \frac{Q_{13}(f)}{\{C_{11}(f)[C_{22}(f) + C_{33}(f)]\}^{1/2}} \\ a_2(f) &= \frac{C_{22}(f) - C_{33}(f)}{C_{22}(f) + C_{33}(f)} \\ b_2(f) &= \frac{2C_{23}(f)}{C_{22}(f) + C_{33}(f)}. \end{aligned} \tag{2}$$

The subscripts 1, 2, and 3 on the co- (C) and quadrature (Q) spectra denote surface elevation, east–west and north–south slopes (translations), respectively (Longuet-Higgins 1963, using a normalization suggested by Long 1980). The Datawell estimates of a_1, b_1, a_2, b_2 follow directly from the measured accelerations and linear wave theory, whereas the NDBC estimates of a_1, b_1 incorporate various corrections for hull-mooring response (see Steele et al. 1992, for details).

Kuik et al. (1988, hereafter KVH) show that for narrow directional spectra the mean direction $\alpha(f)$, directional spread $\sigma(f)$, directional skewness $\gamma(f)$, and directional kurtosis $\delta(f)$ defined as (dropping the frequency dependence)

$$\begin{aligned} \int_{\alpha-\pi}^{\alpha+\pi} d\theta(\theta - \alpha)D(\theta) &= 0 \\ \sigma &= \left[\int_{\alpha-\pi}^{\alpha+\pi} d\theta(\theta - \alpha)^2 D(\theta) \right]^{1/2} \\ \gamma &= \frac{1}{\sigma^3} \int_{\alpha-\pi}^{\alpha+\pi} d\theta(\theta - \alpha)^3 D(\theta) \\ \delta &= \frac{1}{\sigma^4} \int_{\alpha-\pi}^{\alpha+\pi} d\theta(\theta - \alpha)^4 D(\theta) \end{aligned} \tag{3}$$

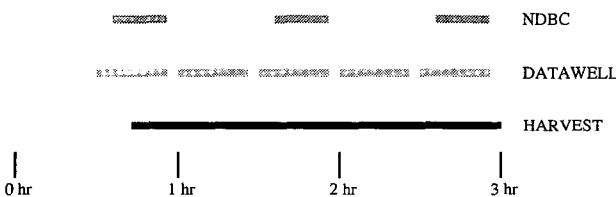

FIG. 3. Schematic of alignment of buoy and array data. The length of each bar corresponds to the duration of each record.

can be approximated using a_1, b_1, a_2, b_2 [Eqs. (1) and (2)]:

$$\alpha = \tan^{-1}\left(\frac{b_1}{a_1}\right) \tag{4a}$$

$$\sigma = [2(1 - m_1)]^{1/2} \tag{4b}$$

$$\gamma = \frac{-n_2}{[(1 - m_2)/2]^{3/2}} \tag{4c}$$

$$\delta = \frac{6 - 8m_1 + 2m_2}{[2(1 - m_1)]^2}, \tag{4d}$$

with

$$m_1 = (a_1^2 + b_1^2)^{1/2} \tag{5a}$$

$$m_2 = a_2 \cos(2\alpha) + b_2 \sin(2\alpha) \tag{5b}$$

$$n_2 = b_2 \cos(2\alpha) - a_2 \sin(2\alpha). \tag{5c}$$

These model-free directional parameters characterize the gross structure of $D(\theta)$ (KVH) and are compared to equivalent platform array estimates in section 5.

4. Array data analysis

The low-order moments a_1, b_1, a_2, b_2 , [Eq. (1)] can be measured accurately with an array of pressure sensors and the assumption of linear wave theory (e.g., Higgins et al. 1981; Herbers and Guza 1989; Herbers et al. 1991). However, wave nonlinearity or distortion of the wave field by the platform structure may introduce significant errors. To determine the frequency range over which both nonlinear and platform effects are small, estimates of a root-mean-square wave number $k_{rms}(f)$,

$$k_{rms}(f) = \left[\frac{\int dk \int k d\theta k^2 E(f, k, \theta)}{\int dk \int k d\theta E(f, k, \theta)} \right]^{1/2}, \tag{6}$$

with $E(f, k, \theta)$ the (vector) wavenumber–frequency spectrum in polar form, were obtained following Herbers and Guza (1994, appendix A) and compared to the linear dispersion relation for surface gravity waves. This test is analogous to the “check ratio” between sea surface slope and elevation spectra often used with directional buoys (e.g., Long, 1980). The wavenumber estimates (lower panel, Fig. 4) typically agree with linear theory to within a few percent for wave frequencies between 0.06 and 0.14 Hz. At frequencies below 0.05 Hz, where energy levels are relatively low (upper panel, Fig. 4), the observed wavenumbers are larger than predicted by linear theory, consistent with the presence of forced waves excited by difference interactions of swell and sea (Herbers et al. 1995). At frequencies above 0.14 Hz, where the wavelength is less than four times the minimum sensor spacing, the observed divergence from the linear dispersion relation may be a result of

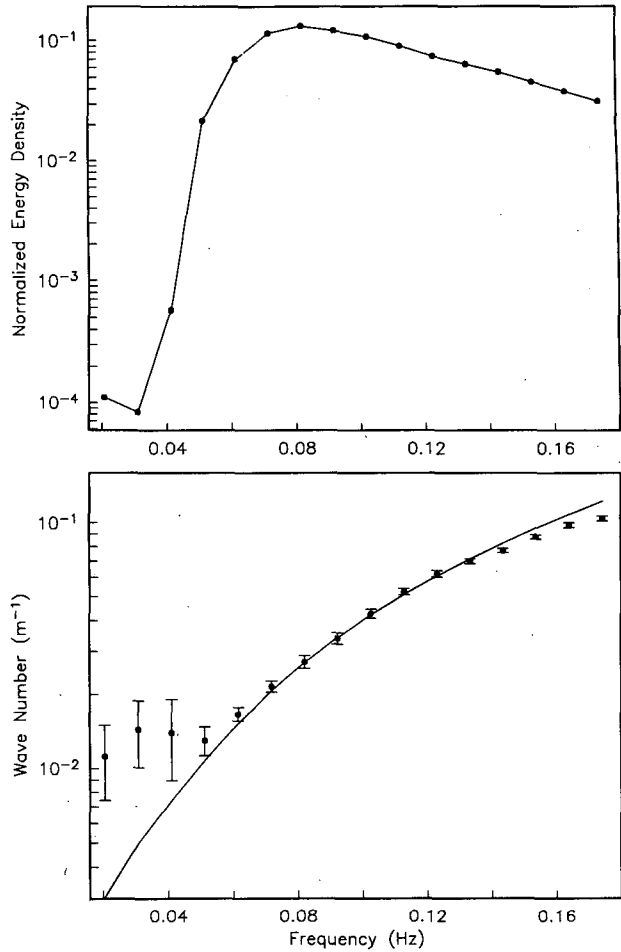

FIG. 4. Average spectral shape and wave numbers observed at Harvest Platform during May 1993. Upper panel: average of surface elevation spectra (each normalized by the total variance in the range 0.02–0.20 Hz). Lower panel: observed root-mean-square wavenumber [dots, Eq. (6)] vs frequency. Bars indicate plus/minus one standard deviation based on 198 data runs. The solid curve is the theoretical linear dispersion relation.

estimator bias, contributions of relatively long wavelength sum-frequency-forced waves (e.g., Herbers and Guza 1994), or effects of the platform structure. The buoy–array comparisons in section 5 are restricted to the 0.06–0.14-Hz frequency range where the array-based wavenumber estimates conform to linear theory. Additional quality-control checks, including comparisons of phase lags from redundant sensor pairs (not shown), confirm the accuracy of the array ground-truth measurements.

The lowest four Fourier coefficients of the directional distribution were estimated directly from the array cross-spectra. At a fixed frequency, an estimate \hat{x} of a moment x of the directional spectrum $E(\theta)$ [$= E(f)D(\theta; f)$],

$$x = \int_0^{2\pi} d\theta G(\theta) E(\theta), \tag{7}$$

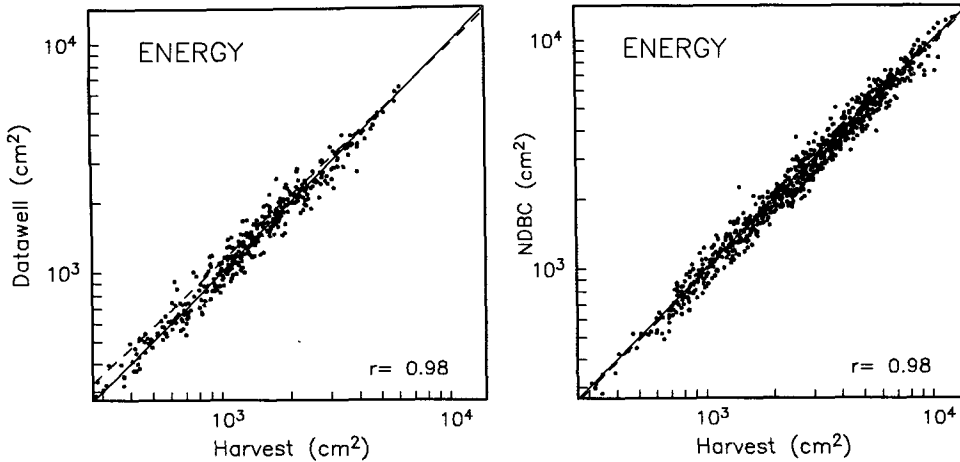

FIG. 5. Comparison of bulk swell energy (0.06–0.14 Hz) estimates from the Harvest Platform array with the Datawell Directional Waverider buoy (left panel, 363 data runs) and the NDBC 3-m discus buoy (right panel, 807 data runs). The dashed lines represent a linear least squares fit with r the correlation coefficient.

[with $G(\theta) = \cos(\theta), \sin(\theta), \cos(2\theta), \sin(2\theta)$ for $x/E = a_1, b_1, a_2, b_2$, Eq. (1)] is formed by taking a linear combination of the cross-spectra, $H_{nm} (= C_{nm} + iQ_{nm})$,

$$\hat{x} = \sum_n \sum_m \beta_{nm} H_{nm}. \tag{8}$$

Optimal coefficients β_{nm} for a_1, b_1, a_2, b_2 are determined by minimizing a weighted average of the bias and statistical variability of the estimate (see Elgar et al. 1994, appendix A, for details).

5. Buoy–array comparisons

Owing to the different sampling schemes of the array and buoys, detailed comparisons of directional moments as a function of frequency were not attempted. Estimates of the KVH directional parameters are based on an integration over the entire swell band (0.06–0.14 Hz). Bulk Fourier moments, $a_1^b, b_1^b, a_2^b, b_2^b$, weighted by the energy density $E(f)$,

$$\begin{bmatrix} a_1^b \\ b_1^b \\ a_2^b \\ b_2^b \end{bmatrix} = \frac{1}{E^b} \int_{0.06 \text{ Hz}}^{0.14 \text{ Hz}} df E(f) \begin{bmatrix} a_1(f) \\ b_1(f) \\ a_2(f) \\ b_2(f) \end{bmatrix}, \tag{9}$$

with E^b the swell variance

$$E^b = \int_{0.06 \text{ Hz}}^{0.14 \text{ Hz}} df E(f) \tag{10}$$

were substituted into Eqs. (3)–(5) to estimate bulk KVH parameters.

Both buoys are in excellent agreement with array measurements of bulk swell variance (Fig. 5) and mean direction (upper panels, Fig. 6). The small bias errors of 2°–3° in mean direction (Table 1) are comparable to the accuracy of a buoy compass. The directional spread estimates of the Datawell buoy are in good

agreement with the array estimates, but the NDBC buoy estimates are biased high by about 6° (lower panels, Fig. 6 and Table 1). Further, the Datawell estimates of skewness are in much better agreement with the platform array estimates than the biased-low and weakly correlated NDBC estimates (upper panels, Fig. 7, Table 1). Both buoys show marginal agreement with the array estimates of directional kurtosis (lower panels, Fig. 7, Table 1).

The scatter in buoy–array comparisons is roughly comparable to results of numerical simulations reported by KVH (Table 2), but significant biases are evident in the NDBC measurements. As shown in Tables 1 and 2 (in parentheses), Datawell estimates with degrees of freedom reduced to approximately those of the NDBC buoy (by skipping every other Datawell run) show little degradation in correlation and bias, and only a small increase in scatter. Hence, the poorer performance of the NDBC buoy cannot be attributed to the lower degrees of freedom in the NDBC estimates.

Some differences in buoy performance may result from the fact that the two buoys were operated during different seasonal wave climates (Table 3). The NDBC data were collected during winter and spring, when the wave climate is dominated by North Pacific swell from a single-source region. During the late spring and summer months when the Datawell data were collected, the wave field is typically a mix of North and South Pacific swell with propagation angles differing by as much as 140°. Therefore, the Datawell buoy data are expected to include more complex wave fields with swell arriving from two distinct source regions. KVH show that skewness γ and kurtosis δ are very sensitive to secondary directional peaks in $D(\theta)$ and thus can be used to identify bimodal directional distributions. The KVH criteria for identifying bimodal, asymmetric distributions are

$$\delta < 2 + |\gamma| \quad \text{and} \quad |\gamma| \leq 4 \tag{11}$$

or

$$\delta < 6 \text{ and } |\gamma| > 4.$$

Using bulk estimates of γ and δ obtained from the array, this criterion is met for 12% of the NDBC data and 68% of the Datawell data, confirming that distinctly different wave climates were encountered during the NDBC and Datawell buoy deployments. Nevertheless, the range of directional spread and skewness values encountered during the deployments was similar and the Datawell estimates are in significantly better agreement with the array ground truth (Figs. 6, 7).

6. Discussion and summary

Directional measurements of ocean swell, obtained with an array of pressure sensors mounted on Harvest Platform in 200-m depth, are used to test the accuracy of nearby NDBC 3-m discus and Datawell Directional

TABLE 1. Correlation and bias between buoy and array estimates of wave energy and the KVH directional parameters. The Datawell results in parentheses use fewer Datawell data records to roughly match the degrees of freedom in the NDBC results.

	Correlation		Bias	
	Datawell	NDBC	Datawell	NDBC
Energy	0.98 (0.98)	0.98	0.9% (1.3)	-2.8%
Direction	0.98 (0.97)	0.96	3.4° (3.4)	2.3°
Spread	0.96 (0.96)	0.86	0.3° (0.3)	5.7°
Skewness	0.88 (0.87)	0.50	0.14 (0.15)	-0.44
Kurtosis	0.89 (0.88)	0.72	0.85 (0.86)	-0.57

Waverider buoys. To enhance the statistical stability, estimates of wave energy, mean propagation direction, and other directional moments are based on integrations over the swell frequency band. Both the Datawell and NDBC buoy compared well with the platform es-

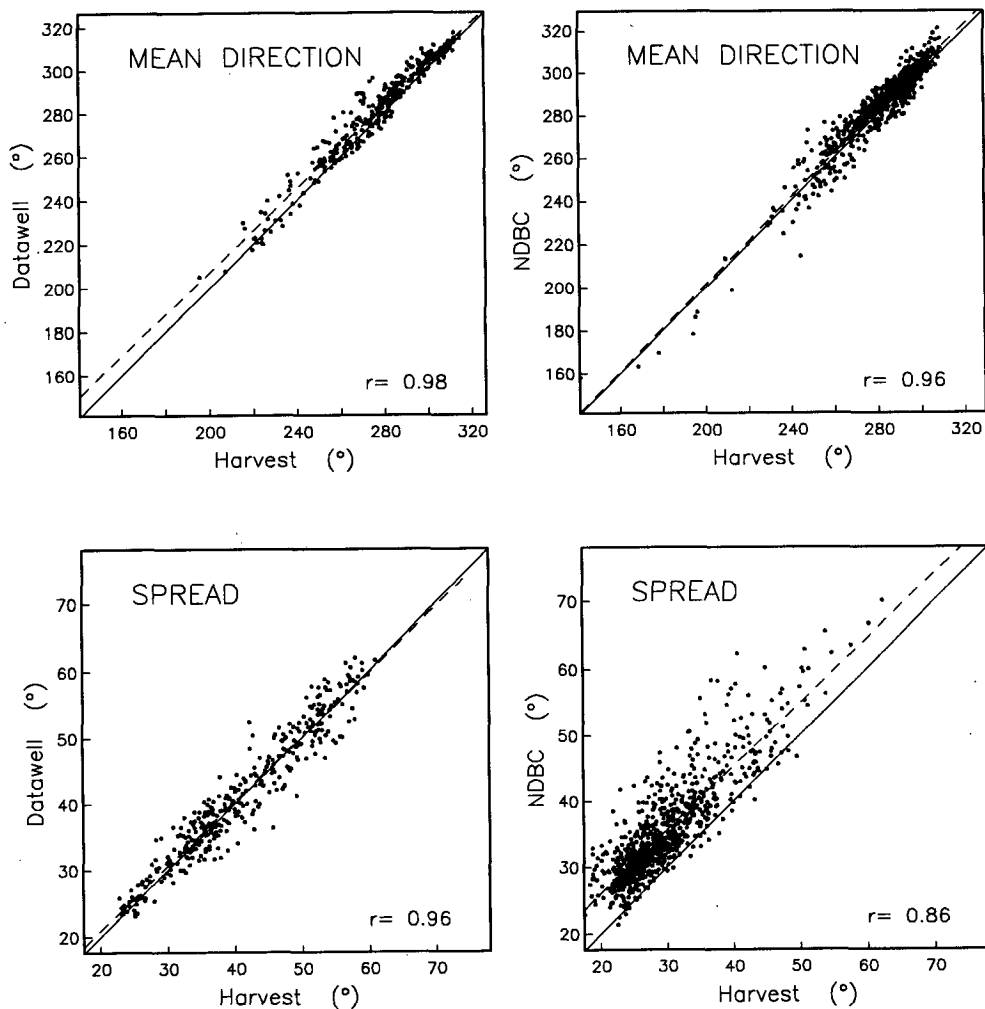

FIG. 6. Comparison of mean direction and spread estimates from the Harvest Platform array with the Datawell Directional Waverider buoy (left panels) and the NDBC 3-m discus buoy (right panels). See Fig. 5 caption.

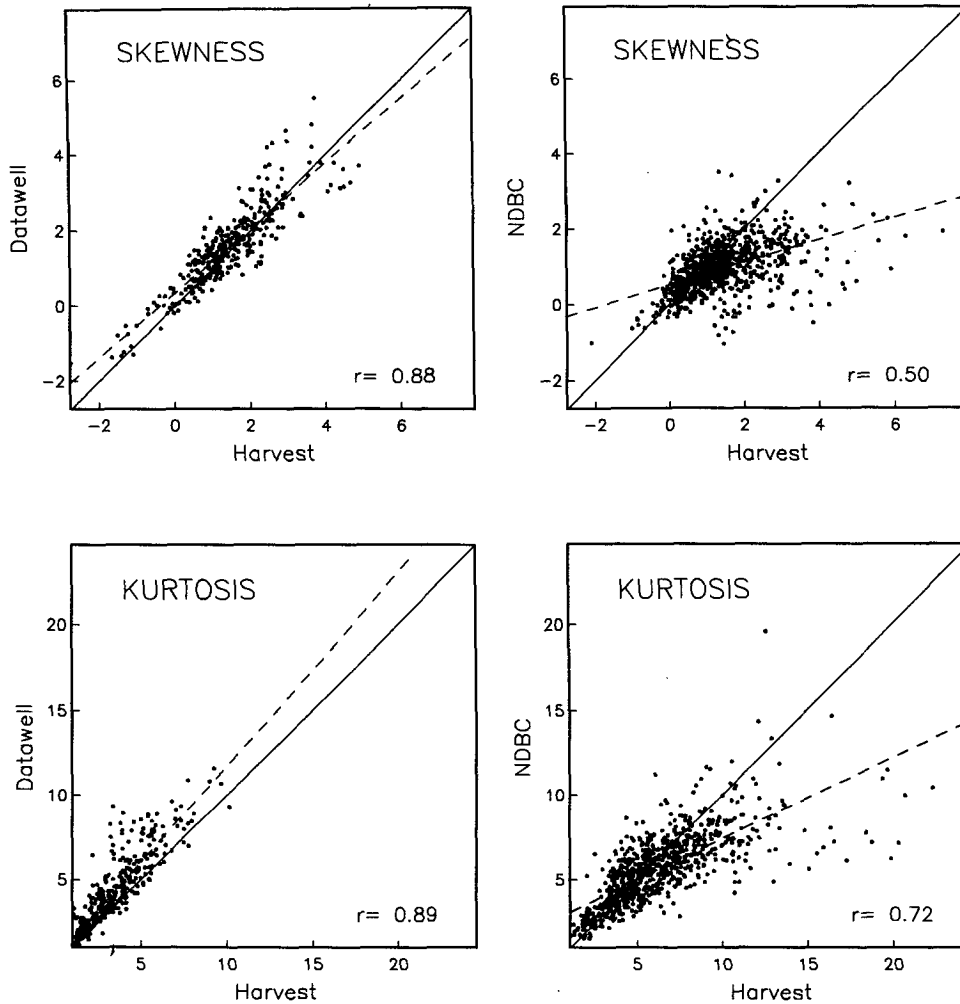

FIG. 7. Comparison of directional skewness and kurtosis estimates from the Harvest Platform array with the Datawell Directional Waverider buoy (left panels) and the NDBC 3-m discus buoy (right panels). See Fig. 5 caption.

timates of energy and mean direction. However, significant biases and low correlations with the array are evident in NDBC estimates of spread and skewness. In particular, the NDBC buoy consistently overpredicted directional spread by about 6°. KVH show through numerical simulations of pitch-roll buoys that low levels of noise (5%) in either the surface elevation

or sea surface slope measurements will not seriously affect estimates of mean direction, but will cause a positive bias in directional spread. This is consistent with the present NDBC pitch-roll buoy results and with the findings of Barstow and Kollstad (1991), where a Datawell buoy measured smaller directional spreads than a pitch-roll NORSCAN buoy.

The accuracy of directional buoys may be strongly frequency dependent. The present comparisons were restricted to swell frequencies where accurate ground-truth measurements were available. Furthermore, the directional moments were integrated over the swell band to reduce the effects of different sampling schemes. Additional comparisons with more extensive ground-truth data, improved sampling schemes, and concurrent buoy data are needed to assess and compare the frequency dependence of directional buoys.

The NDBC buoy in this study was the standard buoy system used up to about 1990. NDBC-SWADE 3-m

TABLE 2. Comparison of rms buoy errors (bias removed) to simulations by KVH based on perfect unbiased measurements with 40 degrees of freedom. The Datawell results in parentheses use fewer Datawell data records to roughly match the degrees of freedom in the NDBC results.

	KVH	Datawell	NDBC
Direction	5°–10°	4.9° (5.5)	5.4°
Spread	10%–15%	6.5% (7.0)	13%
Skewness	30%–50%	39% (44)	67%
Kurtosis	25%–100%	35% (36)	33%

TABLE 3. Mean and range of platform estimates of wave energy and KVH directional parameters for the separate Datawell and NDBC deployment periods.

	Mean		Range	
	Datawell	NDBC	Datawell	NDBC
Energy (cm ²)	1601	3417	281 to 6084	306 to 14436
Direction	279°	283	196 to 315	141 to 309
Spread	41°	30	23 to 61	15 to 62
Skewness	1.4	1.4	-2.7 to 4.9	-2.1 to 9.8
Kurtosis	3.3	6.2	-0.2 to 10.1	1.1 to 22.3

directional buoys (Ancil et al. 1993) are now used almost exclusively by NDBC. In the newer NDBC buoys, a different method is used to remove noise from measured vertical accelerations but only when estimating frequency spectra. This modification does not affect the estimation of directional parameters; therefore, similar directional results would be anticipated for the NDBC-SWADE 3-m buoys.

The NDBC 3-m discus buoy acquires both meteorological and wave data. The stable platform needed for the best possible wind measurements necessarily conflicts with an ideal wave following buoy measuring sea surface slopes. It is unclear from the present comparisons whether the superior performance of the Datawell buoy is primarily due to the measurement of horizontal translations rather than sea surface slopes, or the better wave-following characteristics of the small, spherical Datawell buoy. Support for the former conclusion is provided by a recent field test of the SEAWATCH buoy (Barstow and Haug 1994). Their results demonstrate that horizontal translations can be accurately measured by a stable wind-measuring platform. Based on the buoy-platform comparisons presented here, the Datawell Directional Waverider would be the preferred instrument for studies where very accurate directional measurements of swell are more important than same-platform wind observations.

Acknowledgments. This gauge intercomparison study was conceived and coordinated by Mr. David McGehee, manager of the U.S. Army Corps of Engineers (CE) Field Wave Gaging Program (FWGP). The wave gauge on Harvest Platform is operated by the Coastal Data Information Program (CDIP), a cooperative effort of the CE and the California Department of Boating and Waterways (CDBW). CDIP is managed by the Scripps Institution of Oceanography (SIO) under the supervision of Mr. David Castel.

The Harvest gauge was funded by FWGP, CDBW, and the CE Coastal Research and Development Program. The continuing cooperation and support of the platform owner, Texaco Inc., is gratefully acknowledged. The Datawell buoy for this study was provided by the U.S. Navy Pacific Missile Test Center. Data

collection from both the Harvest array and the Datawell buoy was supervised by Ms. Julie Thomas of SIO. The NDBC buoy was installed and operated by NDBC and funded by the FWGP.

W. C. O'Reilly and R. J. Seymour are sponsored by CE and CDBW through CDIP. T. H. C. Herbers and R. T. Guza are sponsored by the Office of Naval Research. We wish to thank Ken Steele, David Wang, Chung-Chu Teng (all at NDBC), and anonymous reviewers for their helpful comments.

REFERENCES

- Allender, J., T. Audunson, S. F. Barstow, S. Bjerken, H. Krogstad, P. Steinbakke, L. Vartdal, L. Borgman, and C. Graham, 1989: The Wadic Project: A comprehensive field evaluation of directional wave instrumentation. *Ocean Eng.*, **16**, 505-536.
- Ancil, F., M. A. Donelan, G. Z. Forristall, K. E. Steele, and Y. Ouellet, 1993: Deep-water field evaluation of the NDBC-SWADE 3-m discus directional buoy. *J. Atmos. Oceanic Technol.*, **10**, 97-112.
- Barstow, S. F., and T. Kollstad, 1991: Field trials of the Directional Waverider. *Proc. First Int. Offshore and Polar Eng. Conf.*, Edinburgh United Kingdom, ISOPE, 55-63.
- , and O. Huag, 1994: A field validation of a Directional Waverider in a SEAWATCH buoy. *OCEANS 94 OSTAS Conf.*, Brest, France, 32-37.
- Elgar, S., and R. Seymour, 1985: Effects of the lack of stationarity on deep water wave statistics. *Oceans '85. Ocean Engineering and the Environment: Conference Record*, San Diego, CA, **2**, 718-722.
- , T. H. C. Herbers, and R. T. Guza, 1994: Reflection of ocean surface gravity waves from a natural beach. *J. Phys. Oceanogr.*, **24**, 1503-1511.
- Herbers, T. H. C., and R. T. Guza, 1989: Estimation of wave radiation stresses from slope array data. *J. Geophys. Res.*, **94**(C2), 2099-2104.
- , and —, 1994: Nonlinear wave interactions and high-frequency sea floor pressure. *J. Geophys. Res.*, **99**(5), 10 035-10 048.
- , R. L. Lowe, and R. T. Guza, 1991: Field verification of acoustic doppler surface gravity wave measurements. *J. Geophys. Res.*, **96**(C9), 17 023-17 035.
- , S. Elgar, R. T. Guza, and W. C. O'Reilly, 1995: Infragravity-frequency motions on the shelf. Part II: Free waves. *J. Phys. Oceanogr.*, **25**, 1063-1079.
- Higgins, A. L., R. J. Seymour, and S. S. Pawka, 1981: A compact representation of ocean wave directionality. *Appl. Ocean. Res.*, **3**, 105-112.
- Kuik, A. J., G. Ph. van Vledder, and L. H. Holthuisen, 1988: A method for routine analysis of pitch-and-roll buoy data. *J. Phys. Oceanogr.*, **18**, 1020-1034.
- Long, R. B., 1980: The statistical evaluation of directional spectrum estimates derived from pitch-roll measurements. *J. Phys. Oceanogr.*, **10**, 944-952.
- Longuet-Higgins, M. S., D. E. Cartwright, and N. D. Smith, 1963: Observations of the directional spectrum of sea waves using the motions of a floating buoy. *Proc. Conf. Ocean Wave Spectra*, Prentice-Hall, 111-132.
- Seymour, R. J., M. H. Sessions, and D. Castel, 1985: Automated remote recording and analysis of coastal data. *J. Water. Port Coast. Ocean Eng.*, **111**(2), 388-400.
- Seymour, R., D. McGehee, D. Castel, J. Thomas, and W. O'Reilly, 1993: New technology in coastal wave monitoring. *Ocean Wave Measurement and Analysis, Proc. of Second Int. Symp.*, New Orleans, LA, ASCE, 105-123.
- Steele, K. E., C. C. Teng, and D. W. C. Wang, 1992: Wave direction measurements using pitch-roll buoys. *Ocean Eng.*, **19**(4), 349-375.